

# Contactors Motor Protection Accessories

1SBC100129C0201











# ABB Contactor Universal Range

Tailor-made Products for each Application from 6 to 2000 A



## Contents

pages

### Block Contactors ..... 1

- 3-pole  
up to 750 A, AC-3, 400 V  
A 9 ... AF 750 Series
- 4-pole  
up to 125 A, AC-1, 40 °C  
A 9 ... A 75 Series  
200 A up to 1000 A AC-1, 40 °C  
EK 110 ... EK 1000 Series
- D.O.L. Starters
- Star-delta Starters
- Reversing Contactors, Changeover Contactors

### Mini Contactors ..... 41

- 3-pole or 4-pole  
up to 12 A, AC-3, 400 V  
up to 20 A, AC-1, 40 °C  
B 6, B 7 Series

### Bar Mounted Contactors ..... 47

- Variable Number of Poles  
63 up to 2000 A  
IOR 85 ... IORR 2000 Series

### Dimensions and Fixing ..... 51

### Wiring Diagrams ..... 51

# B.. Mini Contactors

# A., AF., EK..



Power rating AC-3, 400 V

Types	3-pole	4kW 5.5kW		3-pole	4kW 5.5kW 7.5kW			11kW 15kW 18.5kW			22kW 30kW	
		<b>B6</b>	<b>B7</b>		<b>A9</b>	<b>A12</b>	<b>A16</b>	<b>A26</b>	<b>A30</b>	<b>A40</b>	<b>A50</b>	<b>A63</b>
Order code (State coil voltage)		B 6-30-10	B 7-30-10		A 9-30-10	A 12-30-10	A 16-30-10	A 26-30-10	A 30-30-10	A 40-30-10	A 50-30-00	A 63-30-00
Rated current AC-3, 400 V	<b>A</b>	<b>9</b>	<b>12</b>	<b>A</b>	<b>9</b>	<b>12</b>	<b>17</b>	<b>26</b>	<b>32</b>	<b>37</b>	<b>50</b>	<b>65</b>
415 V	A	8.5	11.5	A	9	12	17	26	32	37	50	65
690 V	A	—	—	A	7	9	10	17	21	25	35	43
Rated current AC-1, 40 °C	A	16	20	A	25	27	30	45	55	60	100	115

## O/L relays



T7DU 0.4...0.6 2.4...4.0  
0.10...0.16 0.6...1.0 4.0...6.0  
0.16...0.24 1.0...1.6 6.0...9.0  
0.24...0.4 1.6...2.4 9.0...12.0

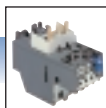

TA 25 DU 0.4...0.63 2.2...3.1 7.5...11  
0.63...1.0 2.8...4.0 10...14  
0.10...0.16 1.0...1.4 3.5...5.0 13...19  
0.16...0.25 1.3...1.8 4.5...6.5 18...25  
0.25...0.4 1.7...2.4 6.0...8.5 24...32

TA 42 DU  
22...32  
29...42

TA 75 DU

## Auxiliary contacts



Side mounting  
1NO + 1NC CA 6-11  
Front mounting  
1NO + 1NC CAF 6-11

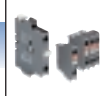

Front mounting 1 NO CA 5-10  
Side mounting 1 NO + 1 NC

## Timers



—



Pneumatic direct  
0.1 ... 40 s TP 40 DA  
10 ... 180 s TP 180 DA

Pneumatic inverse  
0.1 ... 40 s TP 40 IA  
10 ... 180 s TP 180 IA

## Interlocks



Compact reversing  
starters  
VB6A-30-10  
VB7A-30-10



Mechanical / electrical VE 5-1

Mec

## Surge suppressors



Built-in  
on a.c. operated  
mini contactors



RV 5/50  
24 ... 50 V ≅

RV 5/133  
50 ... 133 V ≅

RV 5/250  
110 ... 250 V ≅





Rated current AC-1, 40 °C

Types	4-pole	16 A 20 A		4-pole	25 A 30 A		45 A		70 A	
		<b>B6</b>	<b>B7</b>		<b>A9</b>	<b>A16</b>	<b>A26</b>	<b>A45</b>		
Order code (State coil voltage)		B6-40-00	B7-40-00		A9-40-00	A16-40-00	A26-40-00		A45-40-00	

# Contactors





37kW	45kW	55kW	3-pole 	75kW	90kW	110kW	140kW	160kW	200kW	250kW	315kW	400kW
<b>A 75</b>	<b>A 95</b>	<b>A 110</b>		<b>A 145</b>	<b>A 185</b>	<b>A 210</b>	<b>A 260</b>	<b>A 300</b>	<b>AF400</b>	<b>AF460</b>	<b>AF580</b>	<b>AF750</b>
A 75-30-00	A 95-30-00	A 110-30-00		A 145-30-11	A 185-30-11	A 210-30-11	A 260-30-11	A 300-30-11	AF 400-30-11	AF 460-30-11	AF 580-30-11	AF 750-30-11
75	96	110	A	145	185	210	260	300	400	460	580	750
75	96	110	A	145	185	210	260	300	400	460	580	750
46	65	82	A	120	170	210	220	280	350	400	500	650
125	145	160	A	250	275	350	400	500	600	700	800	1050

29...42 36...52 45...63 60...80	TA 80 DU 60...80	TA 110 DU 65...90 80...110		TA 200 DU 130 ... 175 150 ... 200	E 200 DU 60 ... 200	TA 450 DU 165 ... 235 220 ... 310	E 320 DU 100 ... 320	E 500 DU 150 ... 500	E 800 DU 250 ... 800
--	---------------------	----------------------------------	--	---	------------------------	---	-------------------------	-------------------------	-------------------------

1 NC CA 5-01 CAL 5-11		Side mounting 1 NO + 1 NC CAL 5-11, CAL 5-11B
--------------------------	---	---

Electronic TE5S		Electronic TE5S
-----------------	---	-----------------

Mechanical / electrical VE 5-2		Mechanical VM 300H	Mechanical VM 750H
--------------------------------	---	--------------------	--------------------

RV 5/440 250 ... 440 V ≅		RC 5-2/50 RC 5-2/133 RC 5-2/250 RC 5-2/440 24 ... 50 V~ 50 ... 133 V~ 110 ... 250 V~ 250 ... 440 V~	The built-in coil interface eliminates the need of extra surge suppressors on these sizes
-----------------------------	---	--	---

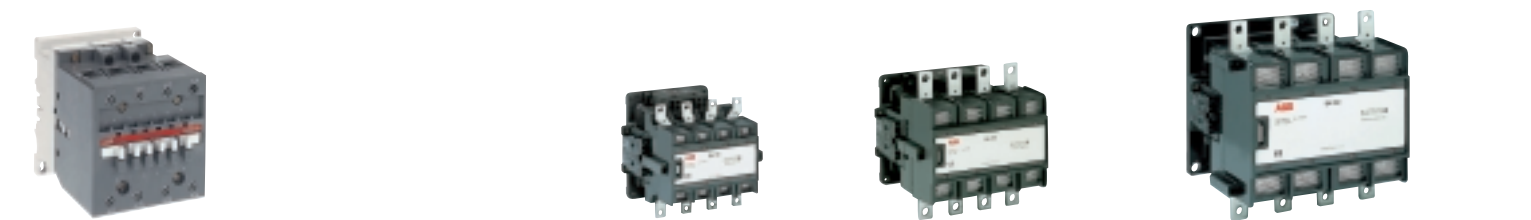

100 A	125 A	4-pole 	200 A	250 A	300 A	350 A	550 A	800 A	1000 A
<b>A 50</b>	<b>A 75</b>		<b>EK110</b>	<b>EK150</b>	<b>EK175</b>	<b>EK210</b>	<b>EK370</b>	<b>EK550</b>	<b>EK1000</b>
A 50-40-00	A 75-40-00		EK110-40-11	EK150-40-11	EK175-40-11	EK210-40-11	EK370-40-11	EK550-40-11	EK1000-40-11





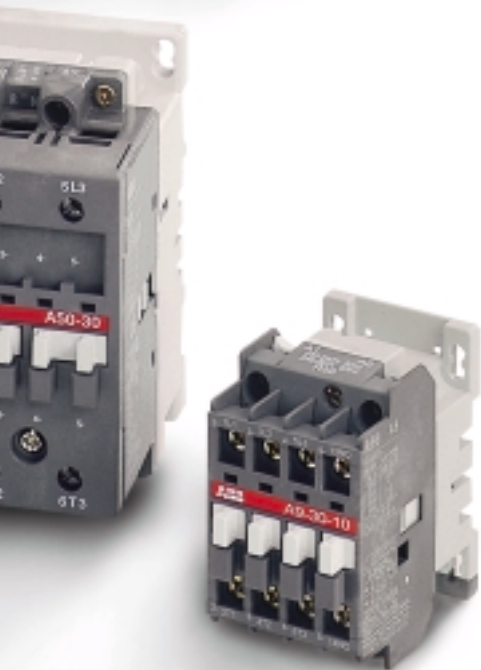

## Contents

### Choose your Components

Switching of Motors AC-3 .....	2
Switching of Resistive Circuits AC-1 .....	4

### Ordering Details

A9 ... A 110 3-pole Contactors, a.c. Coil .....	6
A 145 ... AF 750 3-pole Contactors, a.c. Coil .....	7
Accessories for A9 ... A 110 3-pole Contactors .....	8
Accessories for A 145 ... AF 750 3-pole Contactors .....	10
TA.. Thermal O/L Relays for A9 ... A 110 Contactors .....	14
TA.. Thermal O/L Relays and E... Electronic O/L Relays for A 145 ... AF 750 Contactors ....	15
A9 ... A 75 4-pole Contactors, a.c. Coil .....	16
EK 110 ... EK 1000 4-pole Contactors, a.c. Coil .....	17
Accessories for A.. 4-pole Contactors .....	18
Accessories for EK.. 4-pole Contactors .....	19
N.. Contactor Relays, a.c. Coil .....	20
Accessories for N.. Contactor Relays .....	21
D.A9 ... D.A 16 D.O.L. Starters in Enclosure, a.c. Coil .....	22
YKA..-30 Open Type Star-Delta Starters, a.c. Coil .....	24
VOA..-30M Open Type Reversing Contactors, a.c. Coil .....	26
VOA..-40Z Open Type Changeover Contactors, a.c. Coil .....	28
Contact Sets - Coils .....	30

### Technical Data

Motor Rating and Rated Current .....	31
Technical Data, A9 ... A 110 3-pole Contactors .....	32
Technical Data, A 145 ... AF 750 3-pole Contactors .....	33
Technical Data, A9 ... A 75 4-pole Contactors .....	34
Technical Data, EK 110 ... EK 1000 4-pole Contactors .....	35
Coil Voltages and Codes .....	36

Conversion Tables from B.. / EH.. Series to A.. Series .....	38
--	----



# Choose your Components

## Switching of Motors AC-3

### Motor

Motor rating Rated current 3-phase cage motor, 1500 r.p.m (1) 380 V			
400 V		415 V	
kW	A	kW	A
20	40	-	-
22	44	22	40
25	50	25	47
30	60	30	55
37	72	37	66
-	-	40	72
40	79	-	-
45	85	45	80
-	-	51	90
-	-	55	96
51	97	-	-
55	105	-	-
-	-	59	105
59	112	-	-
75	140	75	135
-	-	80	138
80	147	-	-
90	170	90	165
-	-	100	182
100	188	-	-
110	205	110	200
129	242	129	230
132	245	132	242
140	260	140	250
-	-	147	260
147	273	-	-
160	295	160	280
180	333	180	320
184	340	184	325
200	370	200	340
-	-	220	385
220	408	-	-
250	460	250	425
257	475	257	450
295	546	295	500
-	-	315	535
315	580	-	-
355	636	355	580
-	-	400	650
400	710	-	-

### Contacteur

Rated operational current AC-3 $\theta \leq 55^\circ\text{C}$ 380 V		Type	Auxiliary contacts fitted	
400 V	415 V	State coil voltage: [ ]	I	L
A	A			
50	50	A 50-30-00 [ ]	-	-
50	50	A 50-30-00 [ ]	-	-
50	50	A 50-30-00 [ ]	-	-
65	65	A 63-30-00 [ ]	-	-
75	72	A 75-30-00 [ ]	-	-
75	72	A 75-30-00 [ ]	-	-
96	96	A 95-30-00 [ ]	-	-
96	96	A 95-30-00 [ ]	-	-
96	96	A 95-30-00 [ ]	-	-
96	96	A 95-30-00 [ ]	-	-
110	110	A 110-30-00 [ ]	-	-
110	110	A 110-30-00 [ ]	-	-
110	110	A 110-30-00 [ ]	-	-
145	145	A 145-30-11 [ ]	1	1
145	145	A 145-30-11 [ ]	1	1
145	145	A 145-30-11 [ ]	1	1
185	185	A 185-30-11 [ ]	1	1
185	185	A 185-30-11 [ ]	1	1
185	185	A 185-30-11 [ ]	1	1
210	210	A 210-30-11 [ ]	1	1
210	210	A 210-30-11 [ ]	1	1
260	260	A 260-30-11 [ ]	1	1
260	260	A 260-30-11 [ ]	1	1
260	260	A 260-30-11 [ ]	1	1
260	260	A 260-30-11 [ ]	1	1
305	300	A 300-30-11 [ ]	1	1
305	300	A 300-30-11 [ ]	1	1
400	400	AF 400-30-11 [ ]	1	1
400	400	AF 400-30-11 [ ]	1	1
400	400	AF 400-30-11 [ ]	1	1
400	400	AF 400-30-11 [ ]	1	1
460	460	AF 460-30-11 [ ]	1	1
460	460	AF 460-30-11 [ ]	1	1
580	580	AF 580-30-11 [ ]	1	1
580	580	AF 580-30-11 [ ]	1	1
580	580	AF 580-30-11 [ ]	1	1
580	580	AF 580-30-11 [ ]	1	1
750	750	AF 750-30-11 [ ]	1	1
750	750	AF 750-30-11 [ ]	1	1
750	750	AF 750-30-11 [ ]	1	1

### O/L Relay

Setting range	Type
A	
29 ... 42	TA 75 DU 42
36 ... 52	TA 75 DU 52
36 ... 52	TA 75 DU 52
45 ... 63	TA 75 DU 63
60 ... 80	TA 75 DU 80
60 ... 80	TA 75 DU 80
65 ... 90	TA 110 DU 90
65 ... 90	TA 110 DU 90
80 ... 110	TA 110 DU 110
80 ... 110	TA 110 DU 110
80 ... 110	TA 110 DU 110
80 ... 110	TA 110 DU 110
80 ... 110	TA 110 DU 110
60 ... 200	E 200 DU
60 ... 200	E 200 DU
60 ... 200	E 200 DU
60 ... 200	E 200 DU
60 ... 200	E 200 DU
60 ... 200	E 200 DU
100 ... 320	E 320 DU
100 ... 320	E 320 DU
100 ... 320	E 320 DU
100 ... 320	E 320 DU
100 ... 320	E 320 DU
100 ... 320	E 320 DU
100 ... 320	E 320 DU
100 ... 320	E 320 DU
150 ... 500	E 500 DU
150 ... 500	E 500 DU
150 ... 500	E 500 DU
150 ... 500	E 500 DU
150 ... 500	E 500 DU
150 ... 500	E 500 DU
250 ... 800	E 800 DU
250 ... 800	E 800 DU
250 ... 800	E 800 DU
250 ... 800	E 800 DU
250 ... 800	E 800 DU

(1) The currents shown in the above table are those given for standard three phase squirrel cage motors, 1500 r.p.m. 50 Hz. Values quoted are for guidance only, they can vary depending on the number of poles and design. For motor duty with plugging, inching (utilization category AC-4), please consult us. Motor current values at other operational voltages, see page 31.

#### Coil voltage :

For A 9 ... A 300 50 Hz (V)
24
48
110
220 ... 230
230 ... 240
380 ... 400
400 ... 415

For AF 400 ... AF 750 50/60 Hz or d.c. (V)
24 ... 60 (1)
48 ... 130
100 ... 250
-
-
-
-

#### Kit for mounting on the contactors :

For O/L relay :	For mounting on contactor :	Type
E 500 DU	AF 400 ... AF 460	DT 500/AF 460
E 800 DU	AF 580 ... AF 750	DT 800/AF 750

Other voltages : page 36.

(1) d.c. only

# Choose your Components

## Switching of Resistive Circuits AC-1

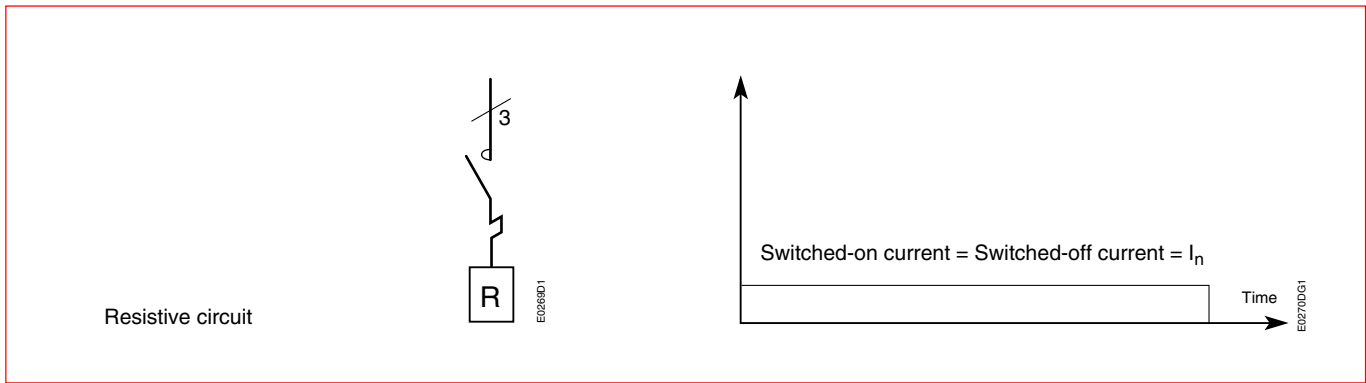

**AC-1 utilization category** When **making**, the switched-on current is equal to the **load rated current  $I_n$**  and  **$\cos \varphi \geq 0.95$** .

**Component selection** Component selection must take into account the air ambient temperature inside the cabinets. The required cable cross-sections or bar dimensions are indicated below.

### 3-pole Contactors

Rated operational current <b>AC-1</b> 380 V - 400 V - 415 V			With cable cross-sections	With bar dimensions	Type	Auxiliary contacts fitted	Max. back-up fuse gG
$\theta \leq 40\text{ }^\circ\text{C}$ A	$\theta \leq 55\text{ }^\circ\text{C}$ A	$\theta \leq 70\text{ }^\circ\text{C}$ A	mm <sup>2</sup>	mm	State coil voltage: [ ] [ ] [ ]		A
25	22	18	2.5	-	A 9-30-10 [ ] [ ] [ ]	1 -	25
27	25	20	4	-	A 12-30-10 [ ] [ ] [ ]	1 -	32
30	27	23	4	-	A 16-30-10 [ ] [ ] [ ]	1 -	32
45	40	32	6	-	A 26-30-10 [ ] [ ] [ ]	1 -	50
55	55	39	10	-	A 30-30-10 [ ] [ ] [ ]	1 -	63
60	60	42	16	-	A 40-30-10 [ ] [ ] [ ]	1 -	63
100	85	70	35	-	A 50-30-00 [ ] [ ] [ ]	- -	100
115	95	80	50	-	A 63-30-00 [ ] [ ] [ ]	- -	125
125	105	85	50	-	A 75-30-00 [ ] [ ] [ ]	- -	160
145	135	115	50	-	A 95-30-00 [ ] [ ] [ ]	- -	160
160	145	130	70	-	A 110-30-00 [ ] [ ] [ ]	- -	200
250	230	180	120	-	A 145-30-11 [ ] [ ] [ ]	1 1	315
275	250	180	150	-	A 185-30-11 [ ] [ ] [ ]	1 1	355
350	300	240	185	-	A 210-30-11 [ ] [ ] [ ]	1 1	400
400	350	290	240	-	A 260-30-11 [ ] [ ] [ ]	1 1	500
500	400	325	300	-	A 300-30-11 [ ] [ ] [ ]	1 1	500
600	500	400	2 x 185	-	AF 400-30-11 [ ] [ ] [ ]	1 1	630
700	600	480	2 x 240	-	AF 460-30-11 [ ] [ ] [ ]	1 1	800
800	700	580	2 x 240	-	AF 580-30-11 [ ] [ ] [ ]	1 1	1000
1050	800	720	-	2 x 80 x 5	AF 750-30-11 [ ] [ ] [ ]	1 1	1000

# Choose your Components

## Switching of Resistive Circuits AC-1

### 4-pole Contactors - 4 NO Main Poles

Rated operational current AC-1 380 V - 400 V - 415 V			With cable cross-sections  mm <sup>2</sup>	Type  State coil voltage: [ ] [ ]	Auxiliary contacts fitted  	Max. back-up fuse gG  A
$\theta \leq 40\text{ }^{\circ}\text{C}$ A	$\theta \leq 55\text{ }^{\circ}\text{C}$ A	$\theta \leq 70\text{ }^{\circ}\text{C}$ A				
25	22	18	2.5	A 9-40-00 [ ] [ ]	- -	25
30	27	23	4	A 16-40-00 [ ] [ ]	- -	32
45	40	32	6	A 26-40-00 [ ] [ ]	- -	50
70	60	50	25	A 45-40-00 [ ] [ ]	- -	80
100	85	70	35	A 50-40-00 [ ] [ ]	- -	100
125	105	85	50	A 75-40-00 [ ] [ ]	- -	160
200	180	155	95	EK 110-40-11 [ ] [ ]	1 1	250
250	230	200	150	EK 150-40-11 [ ] [ ]	1 1	250
300	270	215	185	EK 175-40-11 [ ] [ ]	1 1	355
350	310	250	240	EK 210-40-11 [ ] [ ]	1 1	355
550	470	400	2 x 185	EK 370-40-11 [ ] [ ]	1 1	630
800	650	575	2 x 240	EK 550-40-11 [ ] [ ]	1 1	800
1000	800	720	2 x 300	EK 1000-40-11 [ ] [ ]	1 1	1000

### 4-pole Contactors - 2 NO + 2 NC Main Poles

Rated operational current AC-1 380 V - 400 V - 415 V			With cable cross-sections  mm <sup>2</sup>	Type  State coil voltage: [ ] [ ]	Auxiliary contacts fitted  	Max. back-up fuse gG  A
$\theta \leq 40\text{ }^{\circ}\text{C}$ A	$\theta \leq 55\text{ }^{\circ}\text{C}$ A	$\theta \leq 70\text{ }^{\circ}\text{C}$ A				
25	22	18	2.5	A 9-22-00 [ ] [ ]	- -	25
30	27	21	4	A 16-22-00 [ ] [ ]	- -	32
45	40	32	6	A 26-22-00 [ ] [ ]	- -	50
70	60	50	25	A 45-22-00 [ ] [ ]	- -	80
125	105	85	50	A 75-22-00 [ ] [ ]	- -	160

#### Coil voltage (3-pole contactors) :

For A 9 ... A 300 50 Hz (V)
24
48
110
220 ... 230
230 ... 240
380 ... 400
400 ... 415

Other voltages : see page 36.

For AF 400 ... AF 750 50/60 Hz or d.c. (V)
24 ... 60 (1)
48 ... 130
100 ... 250
-
-
-
-

(1) d.c. only

#### Coil voltage (4-pole contactors) :

For A 9 ... A 75 50 Hz (V)
24
48
110
220 ... 230
230 ... 240
380 ... 400
400 ... 415

Other voltages : see page 36.

For EK 110 ... EK 1000 50 Hz (V)
-
48
110
220 ... 230
230 ... 240
380 ... 400
400 ... 415

>> Aux. contact arrangements and accessories for 3-pole contactors ..... pages 6 to 15  
>> Aux. contact arrangements and accessories for 4-pole contactors ..... pages 14 to 19

>> Dimensions ..... page 51

# A9 ... A110 3-pole Contactors - a.c. Coil

## Ordering Details



A 9-30-10

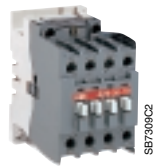

A 26-30-10

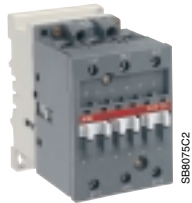

A 50-30-00



A 9 5-30-00

Rated operational current <b>AC-3</b> 380 V 400 V 415 V A	AC-1 $\theta \leq 40^\circ\text{C}$ A	Aux. contacts fitted		Type	Order code	Weight kg	Pack <sup>ing</sup> 1 piece
		1 <sup>st</sup> stack	2 <sup>nd</sup> stack				
9	25	1 - - -	- - -	A 9-30-10	1SBL 14 1001 R□□10	0.340	
		- 1 - -	- - -	A 9-30-01	1SBL 14 1001 R□□01	0.340	
		- - 2 2	- - -	A 9-30-22	1SBL 14 1001 R□□22	0.400	
		1 - 2 2	- - -	A 9-30-32	1SBL 14 1001 R□□32	0.400	
12	27	1 - - -	- - -	A 12-30-10	1SBL 16 1001 R□□10	0.340	
		- 1 - -	- - -	A 12-30-01	1SBL 16 1001 R□□01	0.340	
		- - 2 2	- - -	A 12-30-22	1SBL 16 1001 R□□22	0.400	
		1 - 2 2	- - -	A 12-30-32	1SBL 16 1001 R□□32	0.400	
17	30	1 - - -	- - -	A 16-30-10	1SBL 18 1001 R□□10	0.340	
		- 1 - -	- - -	A 16-30-01	1SBL 18 1001 R□□01	0.340	
		- - 2 2	- - -	A 16-30-22	1SBL 18 1001 R□□22	0.400	
		1 - 2 2	- - -	A 16-30-32	1SBL 18 1001 R□□32	0.400	
26	45	1 - - -	- - -	A 26-30-10	1SBL 24 1001 R□□10	0.600	
		- 1 - -	- - -	A 26-30-01	1SBL 24 1001 R□□01	0.600	
		1 - 2 2	- - -	A 26-30-32	1SBL 24 1001 R□□32	0.660	
32	55	1 - - -	- - -	A 30-30-10	1SBL 28 1001 R□□10	0.710	
		- 1 - -	- - -	A 30-30-01	1SBL 28 1001 R□□01	0.710	
		1 - 2 2	- - -	A 30-30-32	1SBL 28 1001 R□□32	0.770	
37	60	1 - - -	- - -	A 40-30-10	1SBL 32 1001 R□□10	0.710	
		- 1 - -	- - -	A 40-30-01	1SBL 32 1001 R□□01	0.710	
		1 - 2 2	- - -	A 40-30-32	1SBL 32 1001 R□□32	0.770	
50	100	- - - -	- - -	A 50-30-00	1SBL 35 1001 R□□00	1.160	
		1 1 - -	- - -	A 50-30-11	1SBL 35 1001 R□□11	1.200	
		- - 2 2	- - -	A 50-30-22	1SBL 35 1001 R□□22	1.230	
65	115	- - - -	- - -	A 63-30-00	1SBL 37 1001 R□□00	1.160	
		1 1 - -	- - -	A 63-30-11	1SBL 37 1001 R□□11	1.200	
		- - 2 2	- - -	A 63-30-22	1SBL 37 1001 R□□22	1.230	
75	125	- - - -	- - -	A 75-30-00	1SBL 41 1001 R□□00	1.160	
		1 1 - -	- - -	A 75-30-11	1SBL 41 1001 R□□11	1.200	
		- - 2 2	- - -	A 75-30-22	1SBL 41 1001 R□□22	1.230	
96	145	- - - -	- - -	A 95-30-00	1SFL 43 1001 R□□00	2.000	
		1 1 - -	- - -	A 95-30-11	1SFL 43 1001 R□□11	2.040	
		- - 2 2	- - -	A 95-30-22	1SFL 43 1001 R□□22	2.070	
110	160	- - - -	- - -	A 110-30-00	1SFL 45 1001 R□□00	2.000	
		1 1 - -	- - -	A 110-30-11	1SFL 45 1001 R□□11	2.040	
		- - 2 2	- - -	A 110-30-22	1SFL 45 1001 R□□22	2.070	

### Coil voltages and codes: A 9 ... A 110

Voltage (V) 50 Hz : □ □	Voltage (V) 60 Hz : □ □	Voltage code : □ □
24	24	□ 1
48	48	□ 3
110	110...120	□ 4
220 ... 230	230...240	□ 0
230 ... 240	240...260	□ 8
380 ... 400	400...415	□ 5
400 ... 415	415...440	□ 6

Other voltages : page 36.

>> Accessories ..... page 8  
>> Thermal O/L relays ..... page 14

>> Technical data ..... page 32  
>> Dimensions ..... page 51

# A 145 ... AF 750 3-pole Contactors - a.c. Coil

## Ordering Details



A 145-30-11



A 300-30-11



AF 460-30-11



AF 750-30-11

Rated operational current	Auxiliary contacts fitted	Type	Order code		Weight kg
<b>AC-3</b> 380 V <b>400 V</b> 415 V <b>A</b>	<b>AC-1</b> $\theta \leq 40^\circ\text{C}$ <b>A</b>	State coil voltage: [ ][ ]	coil voltage code see table below : [ ][ ]		Pack <sup>ing</sup> 1 piece
145	250	1 1 2 2	A 145-30-11 [ ][ ] A 145-30-22 [ ][ ]	1SFL 47 1001 R [ ][ ]11 1SFL 47 1001 R [ ][ ]22	3.500 3.500
185	275	1 1 2 2	A 185-30-11 [ ][ ] A 185-30-22 [ ][ ]	1SFL 49 1001 R [ ][ ]11 1SFL 49 1001 R [ ][ ]22	3.500 3.500
210	350	1 1 2 2	A 210-30-11 [ ][ ] A 210-30-22 [ ][ ]	1SFL 51 1001 R [ ][ ]11 1SFL 51 1001 R [ ][ ]22	6.100 6.100
260	400	1 1 2 2	A 260-30-11 [ ][ ] A 260-30-22 [ ][ ]	1SFL 53 1001 R [ ][ ]11 1SFL 53 1001 R [ ][ ]22	6.100 6.100
305	500	1 1 2 2	A 300-30-11 [ ][ ] A 300-30-22 [ ][ ]	1SFL 55 1001 R [ ][ ]11 1SFL 55 1001 R [ ][ ]22	6.100 6.100
400	600	1 1 2 2	AF 400-30-11 [ ][ ] AF 400-30-22 [ ][ ]	1SFL 57 7001 R [ ][ ]11 1SFL 57 7001 R [ ][ ]22	12.000 12.000
460	700	1 1 2 2	AF 460-30-11 [ ][ ] AF 460-30-22 [ ][ ]	1SFL 59 7001 R [ ][ ]11 1SFL 59 7001 R [ ][ ]22	12.000 12.000
580	800	1 1 2 2	AF 580-30-11 [ ][ ] AF 580-30-22 [ ][ ]	1SFL 61 7001 R [ ][ ]11 1SFL 61 7001 R [ ][ ]22	15.000 15.000
750	1050	1 1 2 2	AF 750-30-11 [ ][ ] AF 750-30-22 [ ][ ]	1SFL 63 7001 R [ ][ ]11 1SFL 63 7001 R [ ][ ]22	15.000 15.000

### Coil voltages and codes: A 145 ... A 300

Voltage (V) 50 Hz : [ ][ ]	Voltage (V) 60 Hz : [ ][ ]	Voltage code : [ ][ ]
24	24	[8] [1]
48	48	[8] [3]
110	110...120	[8] [4]
220 ... 230	230...240	[8] [0]
230 ... 240	240...260	[8] [8]
380 ... 400	400...415	[8] [5]
400 ... 415	415...440	[8] [6]

Other voltages : page 36.

### Coil voltages and codes: AF 400 ... AF 750

Voltage (V) 50...60 Hz : [ ][ ]	Voltage (V) d.c. [ ][ ]	Voltage code : [ ][ ]
-	24...60	[6] [8]
48...130	48...130	[6] [9]
100...250	100...250	[7] [0]

>> Accessories ..... page 10  
>> Thermal and electronic O/L relays ..... page 15

>> Technical data ..... page 33  
>> Dimensions ..... page 51

# Accessories for A9 ... A110 3-pole Contactors

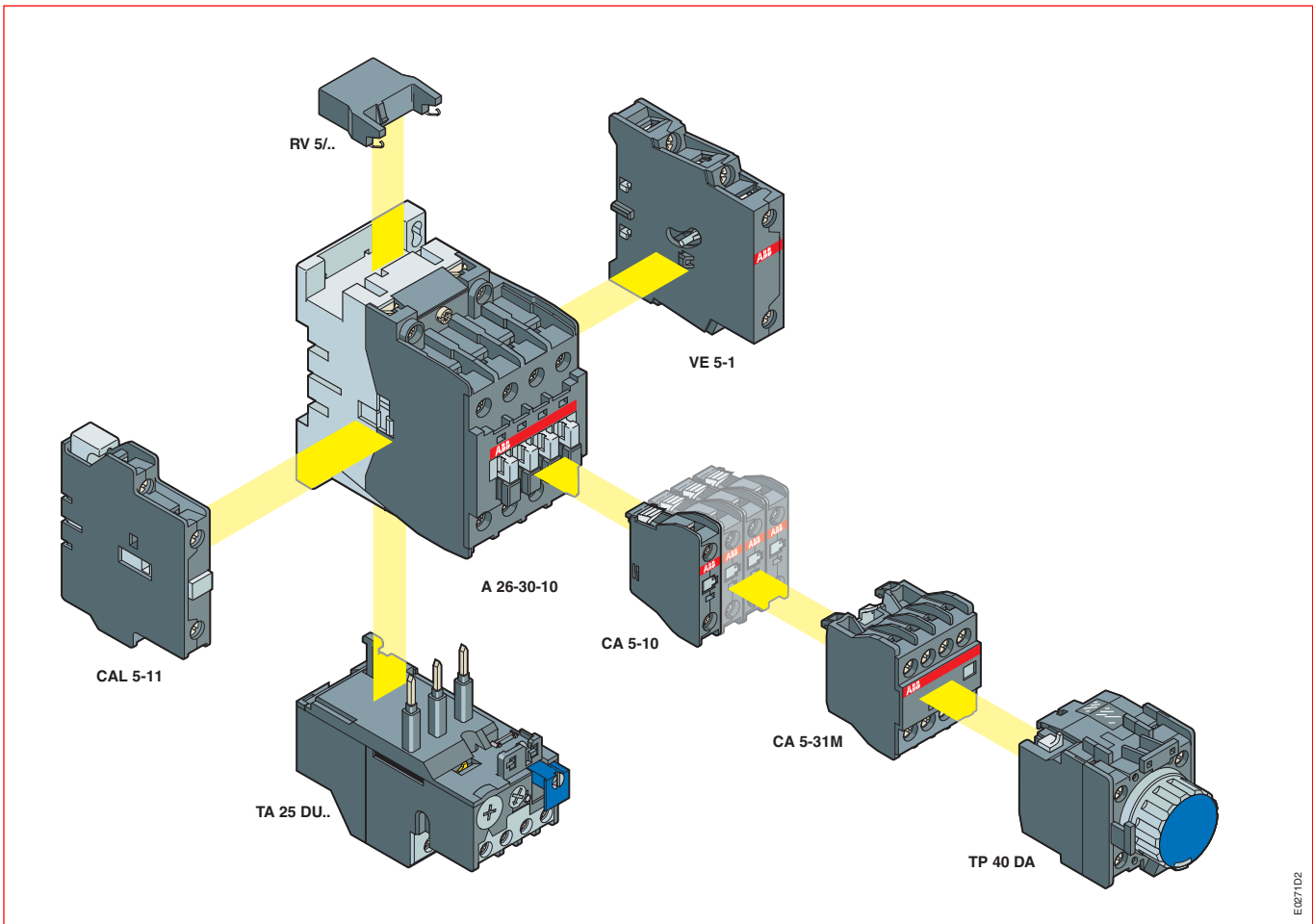

EM21D2

## Contactors

**A9 A12 A16**

**A26 A30 A40**

**A50 A63 A75**

**A95 A110**

## Thermal O/L relays



<b>TA 25 DU</b>	0.4 ...0.63	2.2...3.1	7.5...11	<b>TA 42 DU</b>	22...32
0.10...0.16	1.0 ...1.4	3.5...5.0	13 ...19	29...42	
0.16...0.25	1.3 ...1.8	4.5...6.5	18 ...25		
0.25...0.4	1.7 ...2.4	6.0...8.5	24 ...32		

<b>TA 75 DU</b>	29...42
	36...52
	45...63
	60...80

<b>TA80DU</b>	60...80	<b>TA110DU</b>	65...90
			80...110

## Auxiliary contacts



Front mounting	1 NO CA 5-10	1 NC CA 5-01
Side mounting	1 NO + 1 NC CAL 5-11	

## Timers



Pneumatic direct	Pneumatic inverse
0.1 ... 40 s TP 40 DA	0.1 ... 40 s TP 40 IA
10 ... 180 s TP 180 DA	10 ... 180 s TP 180 IA

Electronic TE5S
--------------------

## Interlocks



Mechanical / electrical VE 5-1	Mechanical / electrical VE 5-2
--------------------------------	--------------------------------

## Surge suppressors



24 ... 50 V ≙ RV 5/50	50 ... 133 V ≙ RV 5/133	110 ... 250 V ≙ RV 5/250	250 ... 440 V ≙ RV 5/440
-----------------------	-------------------------	--------------------------	--------------------------



# Accessories for A9 ... A110 3-pole Contactors

## Ordering Details

### Auxiliary Contact Blocks

Positioning	Mounting on :	Contacts	Type	Order code	Pack <sup>ing</sup> piece	Weight kg
Front face	A 9...A 110	1 -	CA 5-10	1SBN 01 0010 R1010	10	0.014
		- 1	CA 5-01	1SBN 01 0010 R1001	10	0.014
	A 9...A 40	3 1	CA 5-31 M	1SBN 01 0040 R1131	2	0.060
		2 2	CA 5-22 M	1SBN 01 0040 R1122	2	0.060
Side	A 9...A 110	1 1	CAL 5-11	1SBN 01 0020 R1011	2	0.050

### Pneumatic Timers

Mounting on :	Timing range :	Contacts	Type	Order code	Pack <sup>ing</sup> piece	Weight kg
A 9...A 75	Direct 0.1...40s	1 1	TP 40 DA	1SBN 02 0300 R1000	1	0.070
	Direct 10...180s	1 1	TP 180 DA	1SBN 02 0300 R1001	1	0.070
	Inverse 0.1...40s	1 1	TP 40 IA	1SBN 02 0301 R1000	1	0.070
	Inverse 10...180s	1 1	TP 180 IA	1SBN 02 0301 R1001	1	0.070

### Electronic Timers for star-delta starters (dwelling time 50 ms)

Mounting :	Timing range :	Supply voltage	Type	Order code	Pack <sup>ing</sup> piece	Weight kg
Independent	Direct 0.8...8 s or 6...60 s	24 a.c. / d.c.	TE5S-24	1SBN 02 0010 R1001	1	0.080
		110 ... 120 a.c.	TE5S-120	1SBN 02 0010 R1002	1	0.080
		220 ... 240 a.c.	TE5S-240	1SBN 02 0010 R1003	1	0.080
		380 ... 440 a.c.	TE5S-440	1SBN 02 0010 R1004	1	0.080

### Interlocks

Feature	Mounting on :	Contacts	Type	Order code	Pack <sup>ing</sup> piece	Weight kg
Mech. / elec.	A 9...A 40	- 2	VE 5-1	1SBN 03 0110 R1000	1	0.076
	A 50...A 110	- 2	VE 5-2	1SBN 03 0210 R1000	1	0.146
Mechanical	A 9...A 40	- -	VM 5-1	1SBN 03 0100 R1000	1	0.066

Note : Use type VE 5-2 for mechanical and electrical interlocking between contactors A 40 and A 50.

### Surge Suppressors

Feature	Mounting on :	Voltage range	Type	Order code	Pack <sup>ing</sup> piece	Weight kg
Varistor	A 9... A 110	24...50 V ≐	RV 5/50	1SBN 05 0010 R1000	2	0.015
		50...133 V ≐	RV 5/133	1SBN 05 0010 R1001	2	0.015
		110...250 V ≐	RV 5/250	1SBN 05 0010 R1002	2	0.015
		250...440 V ≐	RV 5/440	1SBN 05 0010 R1003	2	0.015
RC	A 9...A 40	24...50 V ~	RC 5-1/50	1SBN 05 0100 R1000	2	0.012
		50...133 V ~	RC 5-1/133	1SBN 05 0100 R1001	2	0.012
		110...250 V ~	RC 5-1/250	1SBN 05 0100 R1002	2	0.012
		250...440 V ~	RC 5-1/440	1SBN 05 0100 R1003	2	0.012
RC	A 50...A 110	24...50 V ~	RC 5-2/50	1SBN 05 0200 R1000	2	0.015
		50...133 V ~	RC 5-2/133	1SBN 05 0200 R1001	2	0.015
		110...250 V ~	RC 5-2/250	1SBN 05 0200 R1002	2	0.015
		250...440 V ~	RC 5-2/440	1SBN 05 0200 R1003	2	0.015

### Auxiliary Lead Terminals

Feature	Mounting on :	Type	Order code	Pack <sup>ing</sup> piece	Weight kg
Clip-on	A 50...A 75	LK 75-L	1SBN 07 3552 R1003	2	0.006
	A 95, A 110	LK 110	1SFN 07 4352 R1000	2	0.010

### Function Marker

Feature	Mounting on :	Type	Order code	Pack <sup>ing</sup> box	Weight kg
50 pcs in a box	A 9...A 110	BA 5-50	1SBN 11 0000 R1000	1	0.017

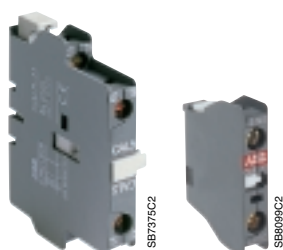

CAL 5-11

CA 5-10



TP 40 DA



TE5S



VE 5-1



RV 5/50

RC 5-1/50

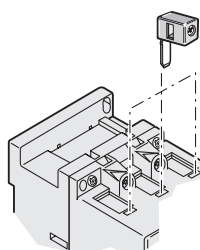

LK 75-L

>> Thermal O/L relays ..... page 14

>> Dimensions ..... page 51

# Accessories for A 145 ... AF 750 3-pole Contactors

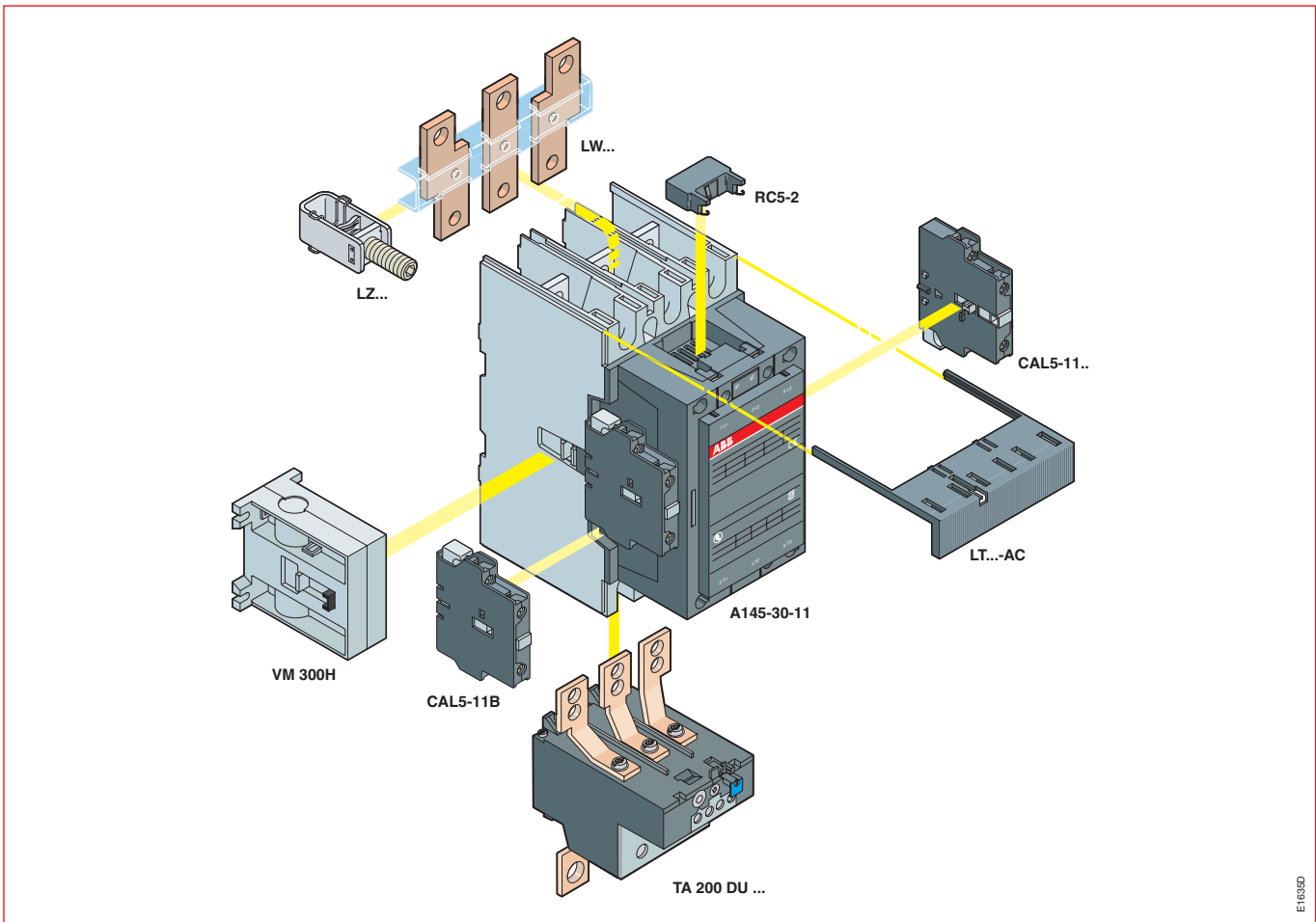

Contactors	A 145	A 185	A 210	A 260	A 300	AF 400	AF 460	AF 580	AF 750
Thermal O/L relays	TA 200 DU 66...200		TA 450 DU 130...310			-		-	
Electronic O/L relays	E 200 DU 60...200		E 320 DU 100...320			E 500 DU 150...500		E 800 DU 250...800	
Auxiliary contacts	Side mounting				1 NO + 1 NC	CAL 5-11 (first block)			
					1 NO + 1 NC	CAL 5-11B (second block)			
Timers	Electronic TE5S								
Interlocks	Mechanical VM 300H					Mechanical VM 300/460H			
						Mechanical VM 750H			
Surge suppressors	24 ... 50 V ~	RC 5-2/50	A 95...A 300			The built-in coil interface eliminates the need of extra surge suppressors on these sizes			
	50...133 V ~	RC 5-2/133	A 145...A 300						
	110...250 V ~	RC 5-2/250	A 145...A 300						
	250...440 V ~	RC 5-2/440	A 145...A 300						

# Accessories for A 145 ... AF 750 3-pole Contactors

## Ordering Details

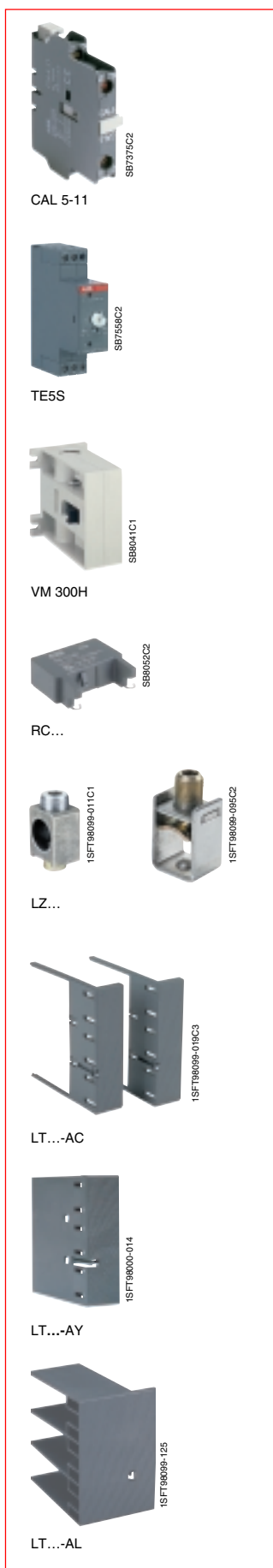

### Auxiliary Contact Blocks

Positioning	Mounting on :	Contacts	Type	Order code	Packing piece	Weight kg
Side	A 145 ... AF 750	1 1	CAL 5-11	1SBN 01 0020 R1011	1	0.050
		1 1	CAL 5-11B	1SBN 01 0420 R3311	1	0.050

### Electronic Timers for star-delta starters (dwelling time 50 ms)

Mounting :	Timing range :	Supply Voltage	Type	Order code	Packing piece	Weight kg
Independent	Direct 0.8 ... 8 s or 6 ... 60 s	24 a.c. / d.c.	TE5S-24	1SBN 02 0010 R1001	1	0.080
		110 ... 120 a.c.	TE5S-120	1SBN 02 0010 R1002	1	0.080
		220 ... 240 a.c.	TE5S-240	1SBN 02 0010 R1003	1	0.080
		380 ... 440 a.c.	TE5S-440	1SBN 02 0010 R1004	1	0.080

### Interlocks for two horizontal mounted contactors

Feature	Left Contactor	Right Contactor	Type	Order code	Packing piece	Weight kg
Mechanical	A 95...A 300	A 145...A 300	VM 300H	1SFN 03 4700 R1000	1	0.150
	A 210...A 300	AF 400...AF 460	VM 300/460H	1SFN 03 5100 R1000	1	0.150
	AF 400...AF 750	AF 400...AF 750	VM 750H	1SFN 03 5700 R1000	1	0.200

### Surge Suppressors

Feature	Mounting on :	Voltage range	Type	Order code	Packing piece	Weight kg
RC	A 145...A 300	24 ... 50 V ~	RC 5-2/50	1SBN 05 0200 R1000	1	0.015
		50 ... 133 V ~	RC 5-2/133	1SBN 05 0200 R1001	1	0.015
		110 ... 250 V ~	RC 5-2/250	1SBN 05 0200 R1002	1	0.015
		250 ... 440 V ~	RC 5-2/440	1SBN 05 0200 R1003	1	0.015

### Connectors

Cables	Mounting on :	cable cross section :	Type	Order code	Packing pieces	Weight kg
Single, Cu	A 145, A 185 A 210...AF 460	6 ... 185 mm <sup>2</sup>	–	1SDA 02 3354 R0001	3	0.200
		16 ... 240 mm <sup>2</sup>	–	1SDA 02 3368 R0001	3	0.400
Single Al & Cu	A 145, A 185 A 210...A 300	35 ... 95 mm <sup>2</sup>	–	1SDA 02 3356 R0001	3	0.100
		25 ... 150 mm <sup>2</sup>	–	1SDA 02 3357 R0001	3	0.100
		120 ... 240 mm <sup>2</sup>	–	1SDA 02 3370 R0001	3	0.200
Double, Cu	A 145, A185	2x(50 ... 120)mm <sup>2</sup>	LZ 185-2C/120	1SFN 07 4709 R1000	3	0.300
Double Al & Cu	A 210...A 300	2x(95 ... 120)mm <sup>2</sup>	–	1SDA 02 5766 R0001	3	0.400

### Shrouds

Suitable for contactor with :	Mounting on :	Type	Order code	Packing pieces	Weight kg
Cable connectors	A 145, A 185	LT 185-AC	1SFN 12 4701 R1000	2	0.050
Cable lugs	A 145, A 185	LT 185-AL	1SFN 12 4703 R1000	2	0.220
For shorting bar LY and between A 145/185 and TA 200 DU	A 145, A 185	LT 185-AY	1SFN 12 4704 R1000	1	0.050
Cable connectors	A 210...A 300	LT 300-AC	1SFN 12 5101 R1000	2	0.070
Cable lugs	A 210...A 300	LT 300-AL	1SFN 12 5103 R1000	2	0.280
For Shorting bar LY 300	A 210...A 300	LT 300-AY	1SFN 12 5104 R1000	1	0.075
Cable connectors	AF 400, AF 460	LT 460-AC	1SFN 12 5701 R1000	2	0.100
Cable lugs	AF 400, AF 460	LT 460-AL	1SFN 12 5703 R1000	2	0.800
Cable connectors	AF 580, AF 750	LT 750-AC	1SFN 12 6101 R1000	2	0.120
Cable lugs	AF 580, AF 750	LT 750-AL	1SFN 12 6103 R1000	2	0.825

>> Thermal and electronic O/L relays ..... page 15

>> Dimensions ..... page 51

# Accessories for A 145 ... AF 750 3-pole Contactors

## Ordering Details

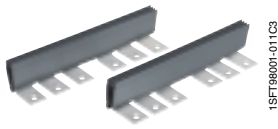

BEM...

1SFT98001-01C3

### Connection bars for reversing contactors

For Contactor :	Type	Order code	Pack <sup>ing</sup> set	Weight kg
A 145, A 185	BEM 185-30	1SFN 08 4701 R1000	1	0.900
A 210...A 300	BEM 300-30	1SFN 08 5101 R1000	1	1.100
AF 400, AF 460	BEM 460-30	1SFN 08 5701 R1000	1	4.400
AF 580, AF 750	BEM 750-30	1SFN 08 6101 R1000	1	7.300



BES...

1SFT98000-09AC6

### Connection phase to phase for 3-pole contactor pairs

For Contactor :	Type	Order code	Pack <sup>ing</sup> set	Weight kg
A 145, A 185	BES 185	1SFN 08 4704 R1000	1	0.500
A 210...A 300	BES 300	1SFN 08 5104 R1000	1	1.000
AF 400, AF 460	BES 460	1SFN 08 5704 R1000	1	2.200
AF 580, AF 750	BES 750	1SFN 08 6104 R1000	1	3.700

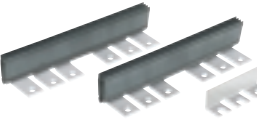

BED...

1SFT98001-01Z

### Connection bars for star-delta starters

Contactors Line and Delta	Star	Type	Order code	Pack <sup>ing</sup> set	Weight kg
A 145	A 110	BED 145A	1SFN 08 4703 R1000	1	1.300
A 185	A 145	BED 185	1SFN 08 4903 R1000	1	1.100
A 210	A 185	BED 210	1SFN 08 5103 R1000	1	1.500
A 260, A 300	A 210, A 260	BED 300	1SFN 08 5303 R1000	1	2.100
AF 400/AF 460	A 260/A 300	BED 400	1SFN 08 5503 R1000	1	3.500
AF 460	AF 400	BED 460	1SFN 08 5703 R1000	1	4.700
AF 580	AF 460/AF 400	BED 580	1SFN 08 5903 R1000	1	6.300
AF 750	AF 580	BED 750	1SFN 08 6103 R1000	1	7.700

# Accessories for A 145 ... AF 750 3-pole Contactors

## Ordering Details



LP...

1SFT9800-010C3

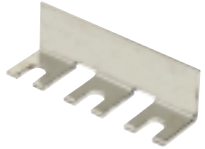

LY...

1SFT9800-013C3

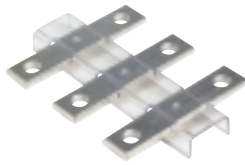

LX...

1SFT9800-012C3



LW...

1SFT9800-011C3

### Connection strip, 2-pole

For Contactor	Type	Order code	Pack <sup>ing</sup> pieces	Weight kg
A 145, A 185	LP 185	1SFN 07 4712 R1000	2	0.300
A 210...A 300	LP 300	1SFN 07 5112 R1000	2	0.400
AF 400, AF 460	LP 460	1SFN 07 5712 R1000	2	0.550
AF 580, AF 750	LP 750	1SFN 07 6112 R1000	2	0.950

### Connection strip, 3-pole

For Contactor	Type	Order code	Pack <sup>ing</sup> piece	Weight kg
A 145, A 185	LY185	1SFN 07 4703 R1000	1	0.200
A 210...A 300	LY 300	1SFN 07 5103 R1000	1	0.300
AF 400, AF 460	LY 460	1SFN 07 5703 R1000	1	0.450
AF 580, AF 750	LY 750	1SFN 07 6103 R1000	1	0.800

### Terminal extensions, 3-pole

For Contactor	Type	Order code	Pack <sup>ing</sup> piece	Weight kg
A 145, A 185	LX 185	1SFN 07 4710 R1000	1	0.250
A 210...A 300	LX 300	1SFN 07 5110 R1000	1	0.350
AF 400, AF 460	LX 460	1SFN 07 5710 R1000	1	0.500
AF 580, AF 750	LX 750	1SFN 07 6110 R1000	1	0.850

### Terminal enlargements, 3-pole

For Contactor	Type	Order code	Pack <sup>ing</sup> piece	Weight kg
A 145, A 185	LW 185	1SFN 07 4707 R1000	1	0.250
A 210...A 300	LW 300	1SFN 07 5107 R1000	1	0.400

# Thermal O/L Relays for A9 ... A 110 Contactors

## Ordering Details



TA 25 DU

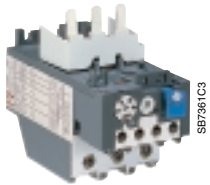

TA 42 DU

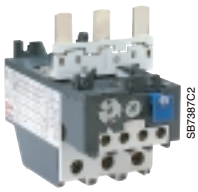

TA 75 DU

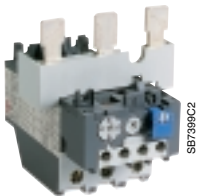

TA 80 DU

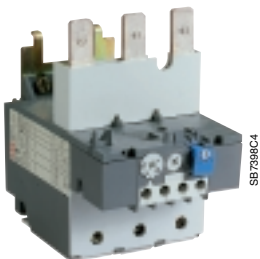

TA 110 DU

<b>A9 A12 A16</b>	<b>A26 A30 A40</b>	<b>A50 A63 A75</b>	<b>A95 A110</b>
<b>TA 25 DU ..</b>	<b>TA 42 DU ..</b>	<b>TA 75 DU ..</b>	<b>TA 80 DU ..</b>
			<b>TA 110 DU ..</b>

### Thermal O/L Relays, Class 10A

For contactor :	Setting range A	Type	Order code	Pack <sup>ing</sup> piece	Weight kg
A 9 ... A 30	0.1 ... 0.16	TA 25 DU 0.16	1SAZ 21 1201 R1005	1	0.150
	0.16 ... 0.25	TA 25 DU 0.25	1SAZ 21 1201 R1009	1	0.150
	0.25 ... 0.4	TA 25 DU 0.4	1SAZ 21 1201 R1013	1	0.150
	0.4 ... 0.63	TA 25 DU 0.63	1SAZ 21 1201 R1017	1	0.150
	0.63 ... 1.0	TA 25 DU 1.0	1SAZ 21 1201 R1021	1	0.150
	1.0 ... 1.4	TA 25 DU 1.4	1SAZ 21 1201 R1023	1	0.150
	1.3 ... 1.8	TA 25 DU 1.8	1SAZ 21 1201 R1025	1	0.150
	1.7 ... 2.4	TA 25 DU 2.4	1SAZ 21 1201 R1028	1	0.150
	2.2 ... 3.1	TA 25 DU 3.1	1SAZ 21 1201 R1031	1	0.150
	2.8 ... 4.0	TA 25 DU 4.0	1SAZ 21 1201 R1033	1	0.150
	3.5 ... 5.0	TA 25 DU 5.0	1SAZ 21 1201 R1035	1	0.150
	4.5 ... 6.5	TA 25 DU 6.5	1SAZ 21 1201 R1038	1	0.150
	6.0 ... 8.5	TA 25 DU 8.5	1SAZ 21 1201 R1040	1	0.150
	7.5 ... 11	TA 25 DU 11	1SAZ 21 1201 R1043	1	0.150
	10 ... 14	TA 25 DU 14	1SAZ 21 1201 R1045	1	0.150
	13 ... 19	TA 25 DU 19	1SAZ 21 1201 R1047	1	0.150
	18 ... 25	TA 25 DU 25	1SAZ 21 1201 R1051	1	0.150
	24 ... 32	TA 25 DU 32	1SAZ 21 1201 R1053	1	0.170
A 30 ... A 40	18 ... 25	TA 42 DU 25	1SAZ 31 1201 R1001	1	0.330
	22 ... 32	TA 42 DU 32	1SAZ 31 1201 R1002	1	0.330
	29 ... 42	TA 42 DU 42	1SAZ 31 1201 R1003	1	0.330
A 50 ... A 75	18 ... 25	TA 75 DU 25	1SAZ 32 1201 R1001	1	0.330
	22 ... 32	TA 75 DU 32	1SAZ 32 1201 R1002	1	0.330
	29 ... 42	TA 75 DU 42	1SAZ 32 1201 R1003	1	0.330
	36 ... 52	TA 75 DU 52	1SAZ 32 1201 R1004	1	0.330
	45 ... 63	TA 75 DU 63	1SAZ 32 1201 R1005	1	0.330
	60 ... 80	TA 75 DU 80	1SAZ 32 1201 R1006	1	0.330
A 95 ... A 110	29 ... 42	TA 80 DU 42	1SAZ 33 1201 R1003	1	0.360
	36 ... 52	TA 80 DU 52	1SAZ 33 1201 R1004	1	0.360
	45 ... 63	TA 80 DU 63	1SAZ 33 1201 R1005	1	0.360
	60 ... 80	TA 80 DU 80	1SAZ 33 1201 R1006	1	0.360
	65 ... 90	TA 110 DU 90	1SAZ 41 1201 R1001	1	0.750
	80 ... 110	TA 110 DU 110	1SAZ 41 1201 R1002	1	0.750

### Separate Mounting Kit

For O/L relays :	Type	Order code	Pack <sup>ing</sup> piece	Weight kg
TA 25 DU ≤ 25	DB 25/25 A	1SAZ 20 1108 R0001	1	0.050
TA 25 DU 32	DB 25/32 A	1SAZ 20 1108 R0002	1	0.075
TA 42 DU, TA 75 DU, TA 80 DU	DB 80	1SAZ 30 1110 R0001	1	0.170
TA 110 DU	DB 200	1SAZ 40 1110 R0001	1	0.230

>> Dimensions ..... page 51

# Thermal O/L Relays and Electronic O/L Relays for A 145 ... AF 750 Contactors

## Ordering Details

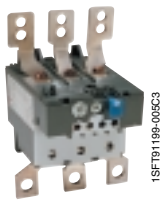

TA 200 DU



TA 450 DU

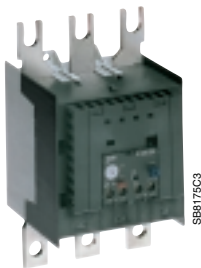

E 320 DU



E 800 DU



A 185 contactor with E 200 DU electronic O/L relay and LT 200 E terminal shroud

A 145, A 185

A 210, A 260, A 300

AF 400, AF 460

AF 580, AF 750

TA 200 DU ...  
E 200 DU ...

TA 450 DU ...  
E 320 DU ...

—  
E 500 DU ...

—  
E 800 DU ...

### Thermal O/L Relays, Class 10A

For contactor :	Setting range A	Type	Order code	Pack <sup>ing</sup> piece	Weight kg
A 145, A 185	66 ... 90	TA 200 DU 90	1SAZ 42 1201 R1001	1	0.750
	80 ... 110	TA 200 DU 110	1SAZ 42 1201 R1002	1	0.750
	100 ... 135	TA 200 DU 135	1SAZ 42 1201 R1003	1	0.750
	110 ... 150	TA 200 DU 150	1SAZ 42 1201 R1004	1	0.750
	130 ... 175	TA 200 DU 175	1SAZ 42 1201 R1005	1	0.750
	150 ... 200	TA 200 DU 200	1SAZ 42 1201 R1006	1	0.750
A 210...A 300	130 ... 185	TA 450 DU 185	1SAZ 51 1201 R1001	1	1.500
	165 ... 235	TA 450 DU 235	1SAZ 51 1201 R1002	1	1.500
	220 ... 310	TA 450 DU 310	1SAZ 51 1201 R1003	1	1.500

### Electronic overload relays, Adjustable Class 10, 20 and 30

For contactor :	Setting range A	Type	Order code	Pack <sup>ing</sup> piece	Weight kg
A 145, A 185	60 ... 200	E 200 DU	1SAX 51 1001 R0001	1	1.120
A 210...A 300	100 ... 320	E 320 DU	1SAX 61 1001 R0002	1	1.260
AF 400, AF 460	150 ... 500	E 500 DU	1SAX 71 1001 R0001	1	1.210
AF 580, AF 750	250 ... 800	E 800 DU	1SAX 81 1001 R0001	1	4.240

### Kit for Mounting on the Contactors

For O/L relays :	On contactor :	Type	Order code	Pack <sup>ing</sup> piece	Weight kg
TA 450 DU/SU	A 145, A 185	DT 450/A 185	1SAZ 50 1901 R1001	1	0.500
	A 210...A 300	DT 450/A 300	1SAZ 50 1902 R1001	1	0.750
E 500 DU	AF 400, AF 460	DT 500/AF 460	1SAX 70 1902 R0001	1	0.720
E 800 DU	AF 580, AF 750	DT 800/AF 750	1SAX 80 1902 R0001	1	1.400

### Separate Mounting Kit

For O/L relay :	Type	Order code	Pack <sup>ing</sup> piece	Weight kg
TA 200 DU	DB 200	1SAZ 40 1110 R0001	1	0.230

### Terminal shrouds for TA 200 DU thermal O/L relay

Fitting	Type	Order code	Pack <sup>ing</sup> piece	Weight kg
Load side	LT 200/A	1SAZ 40 1901 R1001	1	0.070
Between TA 200 DU and A 145, A 185	LT 185-AY	1SFN 12 4704 R1000	1	0.050

### Terminal shrouds for E 200 DU ... E 800 DU electronic O/L relays

For O/L relays :	Type	Order code	Pack <sup>ing</sup> piece	Weight kg
E 200 DU	LT 200 E	1SAX 50 1904 R1001	1	0.120
E 320 DU	LT 320 E	1SAX 60 1904 R1001	1	0.120
E 500 DU	LT 500 E	1SAX 70 1904 R1001	1	0.240
E 800 DU	LT 800 E	1SAX 80 1904 R1001	1	0.240

>> Dimensions ..... page 50

# A9 ... A75 4-pole Contactors - a.c. Coil

## Ordering Details



A 9-40-00



A 45-40-00



A 9-22-00

Rated operational current <b>AC-1</b> $\theta \leq 40 \text{ }^\circ\text{C}$ <b>A</b>	Auxiliary contacts fitted 	Type State coil voltage: <input type="checkbox"/>	Order code coil voltage code see table below : <input type="checkbox"/>	Weight kg Pack <sup>ing</sup> 1 piece
---	----------------------------------	---	---	--

### 4-pole Contactors - 4 NO Main Poles

Rated current (A)	Auxiliary contacts	Type	Order code	Weight (kg)
25	- -	A 9-40-00 <input type="checkbox"/>	1SBL 14 1201 R <input type="checkbox"/> <input type="checkbox"/> 00	0.340
30	- -	A 16-40-00 <input type="checkbox"/>	1SBL 18 1201 R <input type="checkbox"/> <input type="checkbox"/> 00	0.340
45	- -	A 26-40-00 <input type="checkbox"/>	1SBL 24 1201 R <input type="checkbox"/> <input type="checkbox"/> 00	0.610
70	- -	A 45-40-00 <input type="checkbox"/>	1SBL 33 1201 R <input type="checkbox"/> <input type="checkbox"/> 00	1.390
100	- -	A 50-40-00 <input type="checkbox"/>	1SBL 35 1201 R <input type="checkbox"/> <input type="checkbox"/> 00	1.390
125	- -	A 75-40-00 <input type="checkbox"/>	1SBL 41 1201 R <input type="checkbox"/> <input type="checkbox"/> 00	1.390

### 4-pole Contactors - 2 NO + 2 NC Main Poles

Rated current (A)	Auxiliary contacts	Type	Order code	Weight (kg)
25	- -	A 9-22-00 <input type="checkbox"/>	1SBL 14 1501 R <input type="checkbox"/> <input type="checkbox"/> 00	0.340
30	- -	A 16-22-00 <input type="checkbox"/>	1SBL 18 1501 R <input type="checkbox"/> <input type="checkbox"/> 00	0.340
45	- -	A 26-22-00 <input type="checkbox"/>	1SBL 24 1501 R <input type="checkbox"/> <input type="checkbox"/> 00	0.610
70	- -	A 45-22-00 <input type="checkbox"/>	1SBL 33 1501 R <input type="checkbox"/> <input type="checkbox"/> 00	1.400
125	- -	A 75-22-00 <input type="checkbox"/>	1SBL 41 1501 R <input type="checkbox"/> <input type="checkbox"/> 00	1.400

### Coil voltages and codes: A9 ... A75

Voltage (V) 50 Hz : <input type="checkbox"/>	Voltage (V) 60 Hz : <input type="checkbox"/>	Voltage code : <input type="checkbox"/>
24	24	<input type="checkbox"/> <input type="checkbox"/> 1
48	48	<input type="checkbox"/> <input type="checkbox"/> 3
110	110...120	<input type="checkbox"/> <input type="checkbox"/> 4
220 ... 230	230...240	<input type="checkbox"/> <input type="checkbox"/> 0
230 ... 240	240...260	<input type="checkbox"/> <input type="checkbox"/> 8
380 ... 400	400...415	<input type="checkbox"/> <input type="checkbox"/> 5
400 ... 415	415...440	<input type="checkbox"/> <input type="checkbox"/> 6

Other voltages : page 36.



# EK 110 ... EK 1000 4-pole Contactors - a.c. Coil

## Ordering Details



EK 110-40-11

SB7340C3



EK 175-40-11

SB7341C2



EK 370-40-11

SB7342C2



EK 1000-40-11

1SFT98099-098C2

Rated operational current <b>AC-1</b> $\theta \leq 40^\circ\text{C}$ <b>A</b>	Auxiliary contacts fitted 	Type State coil voltage: <input type="checkbox"/> <input type="checkbox"/>	Order code coil voltage code see table below: <input type="checkbox"/> <input type="checkbox"/>	Weight
				kg Pack <sup>kg</sup> 1 piece
200	1 1	EK 110-40-11 <input type="checkbox"/>	SK 824 440 - <input type="checkbox"/> <input type="checkbox"/>	4.300
	2 2	EK 110-40-22 <input type="checkbox"/>	SK 824 450 - <input type="checkbox"/> <input type="checkbox"/>	4.350
250	1 1	EK 150-40-11 <input type="checkbox"/>	SK 824 441 - <input type="checkbox"/> <input type="checkbox"/>	4.350
	2 2	EK 150-40-22 <input type="checkbox"/>	SK 824 451 - <input type="checkbox"/> <input type="checkbox"/>	4.400
300	1 1	EK 175-40-11 <input type="checkbox"/>	SK 825 440 - <input type="checkbox"/> <input type="checkbox"/>	6.600
	2 2	EK 175-40-22 <input type="checkbox"/>	SK 825 448 - <input type="checkbox"/> <input type="checkbox"/>	6.650
350	1 1	EK 210-40-11 <input type="checkbox"/>	SK 825 441 - <input type="checkbox"/> <input type="checkbox"/>	6.600
	2 2	EK 210-40-22 <input type="checkbox"/>	SK 825 451 - <input type="checkbox"/> <input type="checkbox"/>	6.650
550	1 1	EK 370-40-11 <input type="checkbox"/>	SK 827 040 - <input type="checkbox"/> <input type="checkbox"/>	17.200
	2 2	EK 370-40-22 <input type="checkbox"/>	SK 827 042 - <input type="checkbox"/> <input type="checkbox"/>	17.200
800	1 1	EK 550-40-11 <input type="checkbox"/>	SK 827 041 - <input type="checkbox"/> <input type="checkbox"/>	17.200
	2 2	EK 550-40-22 <input type="checkbox"/>	SK 827 043 - <input type="checkbox"/> <input type="checkbox"/>	17.200
1000	1 1	EK 1000-40-11 <input type="checkbox"/>	SK 827 044 - <input type="checkbox"/> <input type="checkbox"/>	17.500
	2 2	EK 1000-40-22 <input type="checkbox"/>	SK 827 045 - <input type="checkbox"/> <input type="checkbox"/>	17.500

### Coil voltages and codes: EK 110 ... EK 1000

Voltage (V) 50 Hz : <input type="checkbox"/> <input type="checkbox"/>	Voltage (V) 60 Hz : <input type="checkbox"/> <input type="checkbox"/>	Voltage code : <input type="checkbox"/> <input type="checkbox"/>
48	-	<input type="checkbox"/> A <input type="checkbox"/> D
-	110	<input type="checkbox"/> A <input type="checkbox"/> E
110	120	<input type="checkbox"/> A <input type="checkbox"/> F
220 ... 230	- *	<input type="checkbox"/> A <input type="checkbox"/> L
230 ... 240	-	<input type="checkbox"/> A <input type="checkbox"/> M
-	380	<input type="checkbox"/> A <input type="checkbox"/> N
380 ... 400	440	<input type="checkbox"/> A <input type="checkbox"/> P
400 ... 415	-	<input type="checkbox"/> A <input type="checkbox"/> R

Other voltages : page 37.

\* 240 V 60 Hz for EK 370 ... EK 1000

>> Accessories ..... page 19

>> Dimensions ..... page 51

>> Technical data ..... page 35

# Accessories for A9 ... A75 4-pole Contactors

## Ordering Details

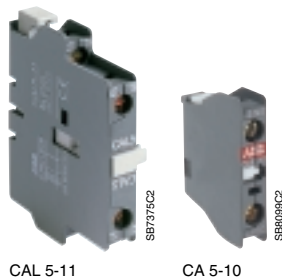

CAL 5-11 SB7754C2  
CA 5-10 SB8099C2

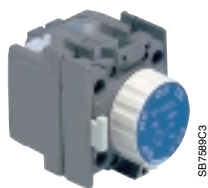

TP 40 DA SB7768C3



VE 5-1 SB7728C2



RV 5/50 SB7400C1  
RC 5-1/50 SB7398C1

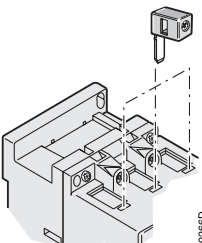

LK 75-L E0268D

### Auxiliary Contact Blocks

Positioning	Mounting on :	Contacts 	Type	Order code	Pack <sup>ing</sup>	Weight
					pieces	kg
Front	A 9...A 75	1 -	CA 5-10	1SBN 01 0010 R1010	10	0.014
		- 1	CA 5-01	1SBN 01 0010 R1001	10	0.014
		4 -	CA 5-40 E	1SBN 01 0040 R1040	2	0.060
		2 2	CA 5-22 E	1SBN 01 0040 R1022	2	0.060
Side	A 9...A 75	1 1	CAL 5-11	1SBN 01 0020 R1011	2	0.050

### Pneumatic Timers

Mounting on :	Timing range :	Contacts 	Type	Order code	Pack <sup>ing</sup>	Weight
					piece	kg
A 9 ... A 75	Direct 0.1...40s	1 1	TP 40 DA	1SBN 02 0300 R1000	1	0.070
	Direct 10 ...180s	1 1	TP 180 DA	1SBN 02 0300 R1001	1	0.070
	Inverse 0.1...40s	1 1	TP 40 IA	1SBN 02 0301 R1000	1	0.070
	Inverse 10 ...180s	1 1	TP 180 IA	1SBN 02 0301 R1001	1	0.070

### Interlocks

Feature	Mounting on :	Contacts 	Type	Order code	Pack <sup>ing</sup>	Weight
					piece	kg
Mech. / elec.	A 9...A 26	2	VE 5-1	1SBN 03 0110 R1000	1	0.076
	A 45...A 75	2	VE 5-2	1SBN 03 0210 R1000	1	0.146
Mechanical	A 9 ...A 26	-	VM 5-1	1SBN 03 0100 R1000	1	0.066

### Surge Suppressors

Feature	Mounting on :	Voltage range	Type	Order code	Pack <sup>ing</sup>	Weight
					pieces	kg
Varistor	A 9...A 75	24...50 V ≐	RV 5/50	1SBN 05 0010 R1000	2	0.015
		50...133 V ≐	RV 5/133	1SBN 05 0010 R1001	2	0.015
		110...250 V ≐	RV 5/250	1SBN 05 0010 R1002	2	0.015
		250...440 V ≐	RV 5/440	1SBN 05 0010 R1003	2	0.015
RC	A 9...A 26	24...50 V ~	RC 5-1/50	1SBN 05 0100 R1000	2	0.012
		50...133 V ~	RC 5-1/133	1SBN 05 0100 R1001	2	0.012
		110...250 V ~	RC 5-1/250	1SBN 05 0100 R1002	2	0.012
		250...440 V ~	RC 5-1/440	1SBN 05 0100 R1003	2	0.012
	A 45...A 75	24...50 V ~	RC 5-2/50	1SBN 05 0200 R1000	2	0.015
		50...133 V ~	RC 5-2/133	1SBN 05 0200 R1001	2	0.015
		110...250 V ~	RC 5-2/250	1SBN 05 0200 R1002	2	0.015
		250...440 V ~	RC 5-2/440	1SBN 05 0200 R1003	2	0.015

### Auxiliary Lead Terminals

Feature	Mounting on :	Type	Order code	Pack <sup>ing</sup>	Weight
				pieces	kg
Clip-on	A 45...A 75	LK 75-L	1SBN 07 3552 R1003	2	0.006

### Function Marker

Feature	Mounting on :	Type	Order code	Pack <sup>ing</sup>	Weight
				box	kg
50 pcs in a box	A 9...A 75	BA 5-50	1SBN 11 0000 R1000	1	0.017

>> Dimensions ..... page 51

# Accessories for EK... 4-pole Contactors

## Ordering Details



CAL 16-11 B



VH 145



RC-EH 300/48

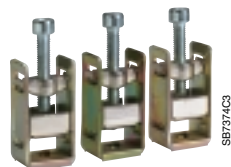

OXFB



TC

TCD



LT 210-EK

### Auxiliary Contact Blocks

Positioning	Mounting on :	Contacts		Type	Order code	Pack <sup>ing</sup> piece	Weight kg
		1	1				
Side	EK 110...EK 1000	1	1	CAL 16-11 B	SK 829 002-B	1	0.050
		1	1	CAL 16-11 C	SK 829 002-C	1	0.050
		1	1	CAL 16-11 D	SK 829 002-D	1	0.050

### Interlocks for two horizontal mounted contactors

Feature	Mounting on :	Contacts		Type	Order code	Pack <sup>ing</sup> piece	Weight kg
		2	2				
Mech./elec.	EK 110, EK 150	2		VH 145	SK 829 071-A	1	0.130
	EK 175, EK 210	2		VH 300	SK 829 071-B	1	0.130
Mechanical	EK 370, EK 550 EK 1000	-		VH 800	SK 829 070-F	1	6.000

Note : For interlocking between two contactors of a different size, please consult us.

### Surge Suppressors

Feature	Mounting on :	Voltage range	Type	Order code	Pack <sup>ing</sup> piece	Weight kg
RC	EK 110 ...EK 210	24...48 V ~	RC-EH 300/48	SK 829 007-A	1	0.015
		110...415 V ~	RC-EH 300/415	SK 829 007-B	1	0.015
	EK 370...EK 1000	48...110 V ~	RC-EH 800/110	SK 829 007-C	1	0.015
		220...600 V ~	RC-EH 800/600	SK 829 007-D	1	0.015

### Connectors

Cables	Mounting on :	cable cross section :	Type	Order code	Pack <sup>ing</sup> pieces	Weight kg
Single, Cu	EK 110 EK 150...EK 210 EK 370...EK 1000	25...120 mm <sup>2</sup>	OXFB 120	SK 175 0003	3	0.060
		25...185 mm <sup>2</sup>	OXFB 185	SK 175 0007	3	0.070
		70...300 mm <sup>2</sup>	OXFB 300	SK 175 0009	3	0.130
Single, Al & Cu	EK 110 EK 150...EK 210 EK 370...EK 1000	10...70 mm <sup>2</sup>	TC 70-15	SK 173 001-AB	3	0.040
		35...120 mm <sup>2</sup>	TC 120-20	SK 173 001-AC	3	0.080
		70...300 mm <sup>2</sup>	TC 300-25	SK 173 001-AD	3	0.160
Double, Al & Cu	EK 370...EK 1000	2x(35...185)mm <sup>2</sup>	TCD 185-25	SK 173 001-BD	3	0.250

### Shrouds

Suitable for contactor with :	Mounting on :	Type	Order code	Pack <sup>ing</sup> piece	Weight kg
cable lugs or	EK 110, EK 150	LT 150-EK	SK 178 001-HB	1	0.139
	EK 175, EK 210	LT 210-EK	SK 178 001-KB	1	0.152
cable clamps	EK 370, EK 550	LT 550-EK	SK 178 001-LB	1	0.190
	EK 1000	LT 1000-EK	SK 178 001-MB	1	0.200

>> Dimensions ..... page 51

# N.. Contactor Relays – a.c. Coil

## Ordering Details

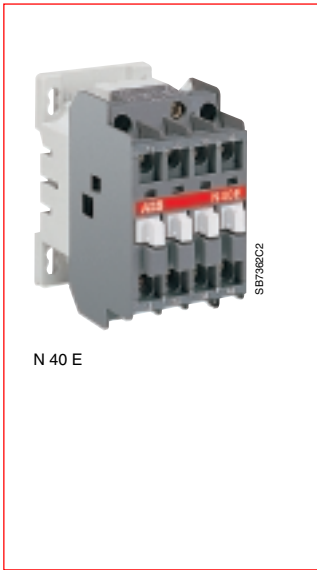

Auxiliary contacts fitted	Type	Order code	Weight kg
	State coil voltage: <input type="text"/>	coil voltage code see table below: <input type="checkbox"/> <input type="checkbox"/>	Pack <sup>ing</sup> 1 piece
4 -	N 40 E <input type="text"/>	1SBH 14 1001 R <input type="checkbox"/> <input type="checkbox"/> 40	0.340
2 2	N 22 E <input type="text"/>	1SBH 14 1001 R <input type="checkbox"/> <input type="checkbox"/> 22	0.340
3 1	N 31 E <input type="text"/>	1SBH 14 1001 R <input type="checkbox"/> <input type="checkbox"/> 31	0.340

### Coil voltages and codes

Voltage (V) 50 Hz : <input type="text"/>	Voltage (V) 60 Hz : <input type="text"/>	Voltage code : <input type="checkbox"/> <input type="checkbox"/>
24	24	<input type="checkbox"/> 1
48	48	<input type="checkbox"/> 3
110	110...120	<input type="checkbox"/> 4
220 ... 230	230...240	<input type="checkbox"/> 0
230 ... 240	240...260	<input type="checkbox"/> 8
380 ... 400	400...415	<input type="checkbox"/> 5
400 ... 415	415...440	<input type="checkbox"/> 6

Other voltages : page 36.

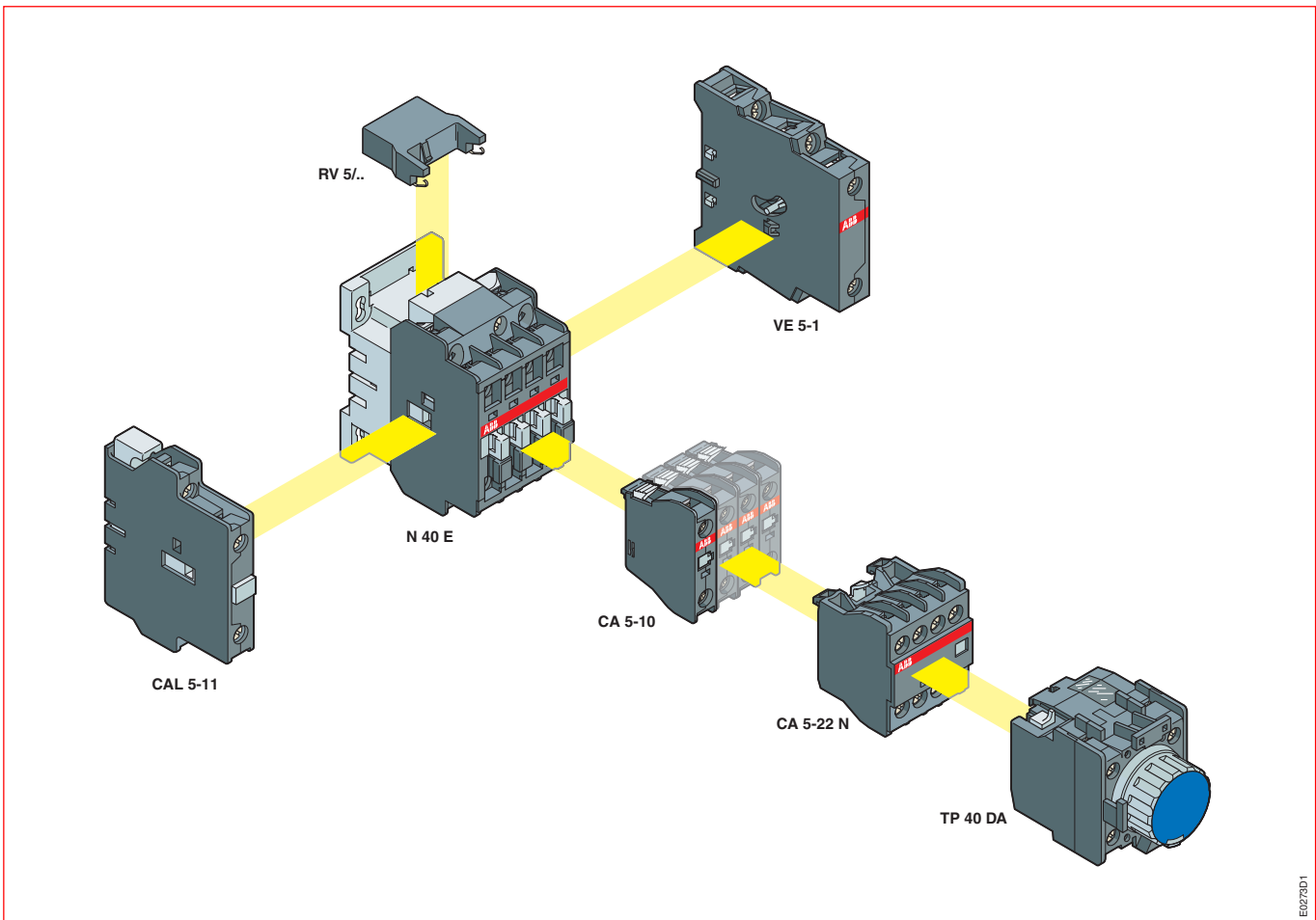

# Accessories for N.. Contactor Relays

## Ordering Details

### Auxiliary Contact Blocks

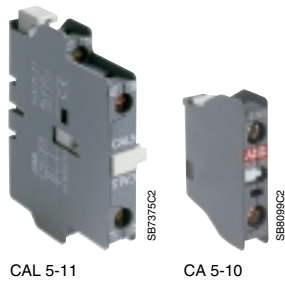

Positioning	Contacts 	Type	Order code	Pack <sup>ing</sup>	Weight
				pieces	kg
Front face	1 -	CA 5-10	1SBN 01 0010 R1010	10	0.014
	- 1	CA 5-01	1SBN 01 0010 R1001	10	0.014
	4 -	CA 5-40 N	1SBN 01 0040 R1240	2	0.060
	2 2	CA 5-22 N	1SBN 01 0040 R1222	2	0.060
	- 4	CA 5-04 N	1SBN 01 0040 R1204	2	0.060
Side	1 1	CAL 5-11	1SBN 01 0020 R1011	2	0.050

### Pneumatic Timers

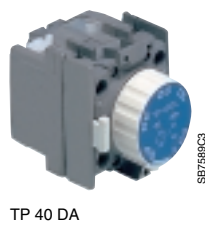

Timing range :	Contacts 	Type	Order code	Pack <sup>ing</sup>	Weight
				piece	kg
Direct 0.1...40s	1 1	TP 40 DA	1SBN 02 0300 R1000	1	0.070
Direct 10...180s	1 1	TP 180 DA	1SBN 02 0300 R1001	1	0.070
Inverse 0.1...40s	1 1	TP 40 IA	1SBN 02 0301 R1000	1	0.070
Inverse 10...180s	1 1	TP 180 IA	1SBN 02 0301 R1001	1	0.070

### Interlocks



Feature	Contacts 	Type	Order code	Pack <sup>ing</sup>	Weight
				piece	kg
Mech. / elec.	2	VE 5-1	1SBN 03 0110 R1000	1	0.076
Mechanical	-	VM 5-1	1SBN 03 0100 R1000	1	0.066

### Surge Suppressors

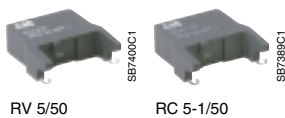

Feature	Voltage range	Type	Order code	Pack <sup>ing</sup>	Weight
				pieces	kg
Varistor	24 ... 50 V ≐	RV 5/50	1SBN 05 0010 R1000	2	0.015
	50 ... 133 V ≐	RV 5/133	1SBN 05 0010 R1001	2	0.015
	110 ... 250 V ≐	RV 5/250	1SBN 05 0010 R1002	2	0.015
	250 ... 440 V ≐	RV 5/440	1SBN 05 0010 R1003	2	0.015
RC	24 ... 50 V ~	RC 5-1/50	1SBN 05 0100 R1000	2	0.012
	50 ... 133 V ~	RC 5-1/133	1SBN 05 0100 R1001	2	0.012
	110 ... 250 V ~	RC 5-1/250	1SBN 05 0100 R1002	2	0.012
	250 ... 440 V ~	RC 5-1/440	1SBN 05 0100 R1003	2	0.012

### Function Marker

Feature	Mounting on contactor relays :	Type	Order code	Pack <sup>ing</sup>	Weight
				box	kg
50 pcs in a box	N	BA 5-50	1SBN 11 0000 R1000	1	0.017

>> Dimensions ..... page 51

# D.A 9 ... D.A 16 D.O.L. Starters in Enclosure

## Ordering Details



### D.O.L. Starters, standard voltages (230 V, 400 V)

Phase to phase coil supply – c/w a factory-fitted connecting strip.

Enclosure version	Rated operational current <b>AC-3</b> 380 V <b>400 V</b> 415 V A	Mounted aux. contacts	Type	Order code (1)	Weight kg	Pack <sup>ing</sup> 1 piece
			state coil voltage: <input type="text"/>	to be completed with coil voltage code: <input type="checkbox"/>		
IP 43	9	1 -	DWA 9-30 <input type="text"/>	1SBK 140 118 R8 <input type="checkbox"/> 00	0.810	
	12	1 -	DWA 12-30 <input type="text"/>	1SBK 160 118 R8 <input type="checkbox"/> 00	0.810	
	17	1 -	DWA 16-30 <input type="text"/>	1SBK 180 118 R8 <input type="checkbox"/> 00	0.810	
IP 65	9	1 -	DYA 9-30 <input type="text"/>	1SBK 140 128 R8 <input type="checkbox"/> 00	0.810	
	12	1 -	DYA 12-30 <input type="text"/>	1SBK 160 128 R8 <input type="checkbox"/> 00	0.810	
	17	1 -	DYA 16-30 <input type="text"/>	1SBK 180 128 R8 <input type="checkbox"/> 00	0.810	

(1) Thermal O/L relay to be ordered separately, see ordering details page 23.

### Coil voltages and codes

Voltage (V) 50 Hz : <input type="text"/>	Voltage (V) 60 Hz : <input type="text"/>	Coil voltage code : <input type="checkbox"/>
220 ... 230	230...240	<input type="checkbox"/>
380 ... 400	400...415	<input type="checkbox"/>

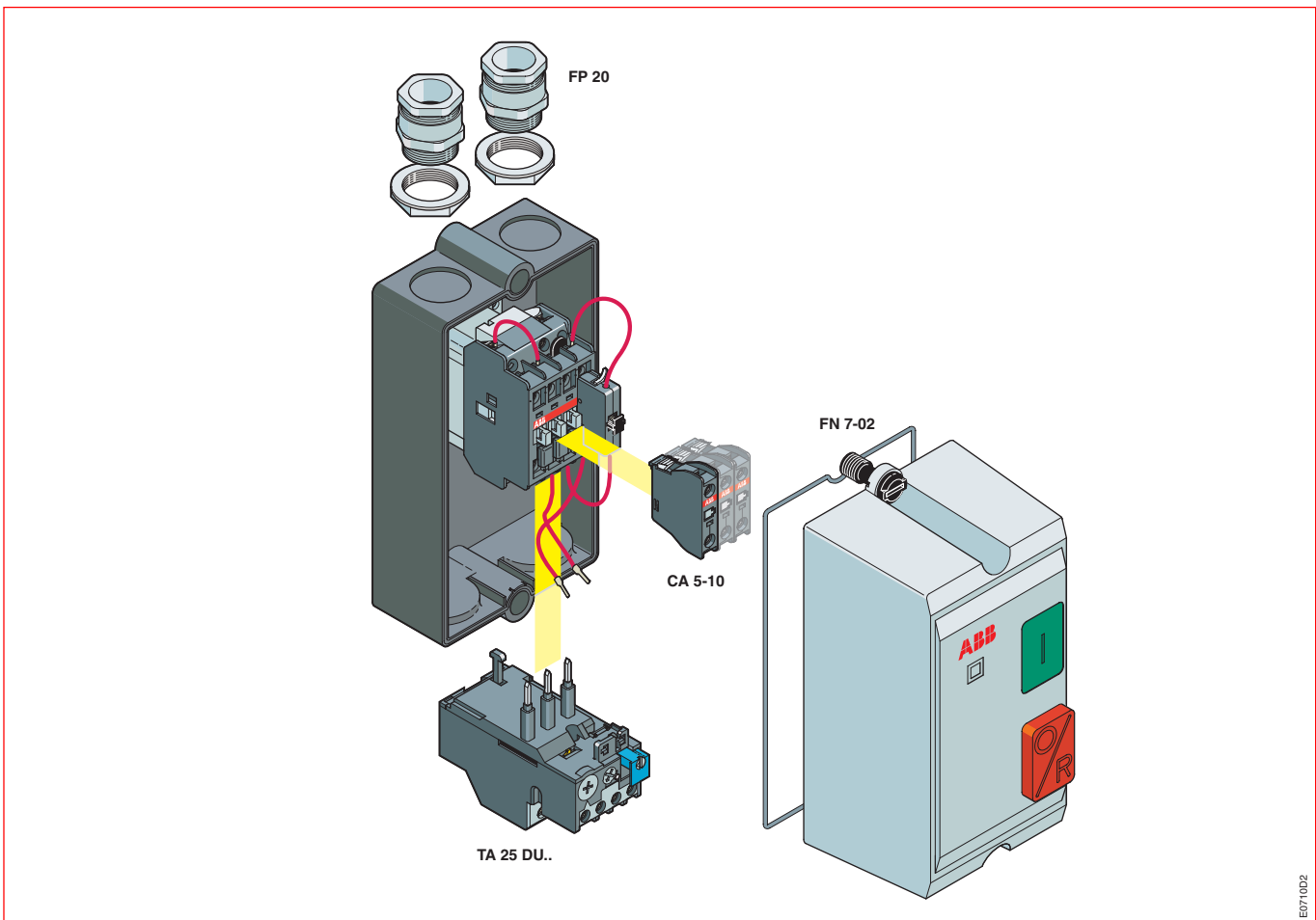

# D.A 9 ... D.A 16 D.O.L. Starters

## Ordering Details



DYA 9-30



TA 25 DU



CA 5-10



FW 16-12 VARS

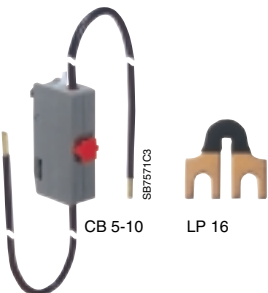

### Coil voltages and codes

Voltage (V) 50 Hz :	Voltage (V) 60 Hz :	Coil voltage code :
24	24	1
48	48	3
110	110...120	4

### D.O.L. Starters, other voltages

Separate coil supply : control circuit (24 V, 48 V, 110 V) to be connected when putting the starter into service.

Enclosure version	Rated operational current AC-3 380 V 400 V 415 V A	Mounted aux. contacts	Type	Order code (1)	Pack <sup>ing</sup> Weight piece kg
			State coil voltage: <input type="checkbox"/>	to be completed with coil voltage code : <input type="checkbox"/>	
IP 43	9 12 17	1 - 1 - 1 -	DWA 9-30 <input type="checkbox"/> DWA 12-30 <input type="checkbox"/> DWA 16-30 <input type="checkbox"/>	1SBK 140 018 R8 <input type="checkbox"/> 00 1SBK 160 018 R8 <input type="checkbox"/> 00 1SBK 180 018 R8 <input type="checkbox"/> 00	1 0.810 1 0.810 1 0.810
IP 65	9 12 17	1 - 1 - 1 -	DYA 9-30 <input type="checkbox"/> DYA 12-30 <input type="checkbox"/> DYA 16-30 <input type="checkbox"/>	1SBK 140 028 R8 <input type="checkbox"/> 00 1SBK 160 028 R8 <input type="checkbox"/> 00 1SBK 180 028 R8 <input type="checkbox"/> 00	1 0.810 1 0.810 1 0.810

(1) Thermal O/L relay to be ordered separately, see table below.

### Thermal O/L Relays

Setting range A	Type	Order code	Pack <sup>ing</sup> Weight piece kg
0.1 ... 0.16	TA 25 DU 0.16	1SAZ 21 1201 R1005	1 0.150
0.16 ... 0.25	TA 25 DU 0.25	1SAZ 21 1201 R1009	1 0.150
0.25 ... 0.4	TA 25 DU 0.4	1SAZ 21 1201 R1013	1 0.150
0.4 ... 0.63	TA 25 DU 0.63	1SAZ 21 1201 R1017	1 0.150
0.63 ... 1.0	TA 25 DU 1.0	1SAZ 21 1201 R1021	1 0.150
1.0 ... 1.4	TA 25 DU 1.4	1SAZ 21 1201 R1023	1 0.150
1.3 ... 1.8	TA 25 DU 1.8	1SAZ 21 1201 R1025	1 0.150
1.7 ... 2.4	TA 25 DU 2.4	1SAZ 21 1201 R1028	1 0.150
2.2 ... 3.1	TA 25 DU 3.1	1SAZ 21 1201 R1031	1 0.150
2.8 ... 4.0	TA 25 DU 4.0	1SAZ 21 1201 R1033	1 0.150
3.5 ... 5.0	TA 25 DU 5.0	1SAZ 21 1201 R1035	1 0.150
4.5 ... 6.5	TA 25 DU 6.5	1SAZ 21 1201 R1038	1 0.150
6.0 ... 8.5	TA 25 DU 8.5	1SAZ 21 1201 R1040	1 0.150
7.5 ... 11.0	TA 25 DU 11	1SAZ 21 1201 R1043	1 0.150
10.0 ... 14.0	TA 25 DU 14	1SAZ 21 1201 R1045	1 0.150
13.0 ... 19.0	TA 25 DU 19	1SAZ 21 1201 R1047	1 0.150

### Accessories for D.O.L. Starters

Description	Type	Order code	Pack <sup>ing</sup> Weight pieces kg
N.O. 1-pole auxiliary contact block	CA 5-10	1SBN 010010 R1010	10 0.014
N.C. 1-pole auxiliary contact block	CA 5-01	1SBN 010010 R1011	10 0.014
ISO 20 cable gland	FP 20	1SBN 110312 R1000	2 0.008
"Start" button interlocking lever	BD 7	FPMP 307404 R0001	10 0.003
IP 65 sealing gasket set	FN 7-02	FPTN 472619 R0001	1 0.005

### D.O.L. Starters, in kit form

Description	Type	Order code (1)	Pack <sup>ing</sup> Weight pieces kg
Empty enclosure, IP 43 c/w Start and Stop/Reset pushbuttons	FW 16-12 VARS	FPTN 372630 R0050	1 0.495
Empty enclosure, IP 65 c/w Start and Stop/Reset pushbuttons	FY 16-12 VARS	FPTN 372630 R0051	1 0.500
"Start" contact	CB 5-10	1SBN 010013 R1010	1 0.012
Connecting strip	LP 16	FPEP 407000 R0001	10 0.002

1) Contactor and thermal O/L relay to be ordered separately.

>> Technical data (see A 9 ... A 16 contactors) ..... page 32

>> Dimensions ..... page 51

# Open Type Star-Delta Starters – a.c. Coil YKA 9-30 ... YKA 75-30

## Ordering Details

**Star-Delta starters, factory-assembled.** Thermal O/L relay to be ordered separately (1).

Rated operational current AC-3		Type	Order code	Weight kg
380 V	415 V	State coil voltage: <input type="checkbox"/>	to be completed with coil voltage code : <input type="checkbox"/>	Packing 1 piece
<b>400 V</b>	<b>A</b>	<b>A</b>		
15.5	14	YKA 9-30 <input type="checkbox"/>	1SBK 14 2301 R8 <input type="checkbox"/> 00	1.610
22	21	YKA 12-30 <input type="checkbox"/>	1SBK 16 2301 R8 <input type="checkbox"/> 00	1.610
30	28	YKA 16-30 <input type="checkbox"/>	1SBK 18 2301 R8 <input type="checkbox"/> 00	1.610
44	40	YKA 26-30 <input type="checkbox"/>	1SBK 24 2301 R8 <input type="checkbox"/> 00	2.120
50	47	YKA 30-30 <input type="checkbox"/>	1SBK 28 2301 R8 <input type="checkbox"/> 00	3.125
72	66	YKA 40-30 <input type="checkbox"/>	1SBK 32 2301 R8 <input type="checkbox"/> 00	3.135
85	80	YKA 50-30 <input type="checkbox"/>	1SBK 35 2301 R8 <input type="checkbox"/> 00	4.130
105	96	YKA 63-30 <input type="checkbox"/>	1SBK 37 2301 R8 <input type="checkbox"/> 00	4.135
119	126	YKA 75-30 <input type="checkbox"/>	1SBK 41 2301 R8 <input type="checkbox"/> 00	4.480

(1) The setting current value is : motor rated current  $I_n$  x 0.58.

### Coil voltages and codes

Voltage (V) 50 Hz : <input type="checkbox"/>	Voltage (V) 60 Hz : <input type="checkbox"/>	Coil voltage code : <input type="checkbox"/>
24	24	<input type="checkbox"/> 1
110	110...120	<input type="checkbox"/> 4
220 ... 230	230...240	<input type="checkbox"/> 0
380 ... 400	400...415	<input type="checkbox"/> 5

### Other Versions:

- starter control circuit is suitable for separate supply. For direct supply version, please consult us.
- starter c/w mechanical interlocking, please consult us.

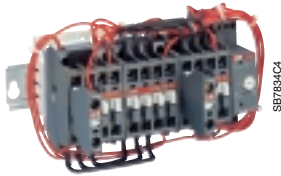

YKA 16-30

SE7894/C4

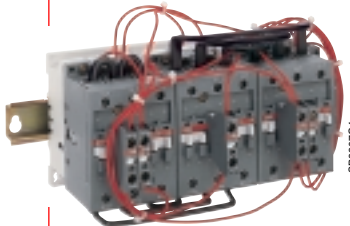

YKA 75-30

SBB07/C4

### Starters in kit form

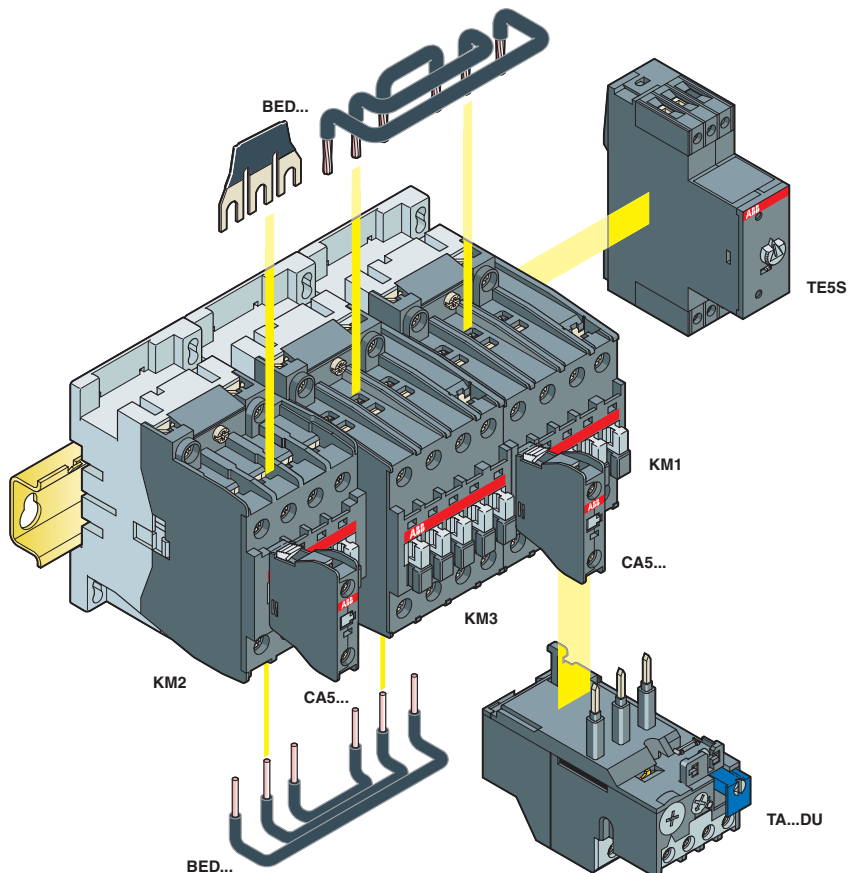

E1121D3

>> Contactor technical data ..... page 32  
>> Accessories ..... page 10

>> Thermal O/L relays ..... page 14  
>> Dimensions and wiring diagrams ..... page 51



# Open Type Star-Delta Starters – a.c. Coil in Kit Form

## Ordering details

### Components for Star-Delta Starters, in kit form

Rated operational current AC-3 380 V 400 V 415 V A A	Line Contactor		Star Contactor $\wedge$	Delta Contactor $\Delta$	Thermal O/L relay (1) FR1	Required accessories (see table below).
	KM1	Type, state coil voltage: <input type="checkbox"/> Order code, to be completed with coil voltage code : <input type="checkbox"/>	KM2	KM3	Type Order code	Reference letters
15.5 14	A 9-30-10 <input type="checkbox"/> 1SBL 14 1001 R8 <input type="checkbox"/> 10	A 9-30-01 <input type="checkbox"/> 1SBL 14 1001 R8 <input type="checkbox"/> 01	A 9-30-01 <input type="checkbox"/> 1SBL 14 1001 R8 <input type="checkbox"/> 01	TA 25 DU 11 1SAZ 21 1201 R1043	A	
22 21	A 12-30-10 <input type="checkbox"/> 1SBL 16 1001 R8 <input type="checkbox"/> 10	A 9-30-01 <input type="checkbox"/> 1SBL 14 1001 R8 <input type="checkbox"/> 01	A 12-30-01 <input type="checkbox"/> 1SBL 16 1001 R8 <input type="checkbox"/> 01	TA 25 DU 14 1SAZ 21 1201 R1045	A	
30 28	A 16-30-10 <input type="checkbox"/> 1SBL 18 1001 R8 <input type="checkbox"/> 10	A 12-30-01 <input type="checkbox"/> 1SBL 16 1001 R8 <input type="checkbox"/> 01	A 16-30-01 <input type="checkbox"/> 1SBL 18 1001 R8 <input type="checkbox"/> 01	TA 25 DU 19 1SAZ 21 1201 R1047	A	
44 40	A 26-30-10 <input type="checkbox"/> 1SBL 24 1001 R8 <input type="checkbox"/> 10	A 16-30-01 <input type="checkbox"/> 1SBL 18 1001 R8 <input type="checkbox"/> 01	A 26-30-01 <input type="checkbox"/> 1SBL 24 1001 R8 <input type="checkbox"/> 01	TA 25 DU 25 1SAZ 21 1201 R1051	B	
50 47	A 30-30-10 <input type="checkbox"/> 1SBL 28 1001 R8 <input type="checkbox"/> 10	A 26-30-01 <input type="checkbox"/> 1SBL 24 1001 R8 <input type="checkbox"/> 01	A 30-30-01 <input type="checkbox"/> 1SBL 28 1001 R8 <input type="checkbox"/> 01	TA 25 DU 32 1SAZ 21 1201 R1053	C	
72 66	A 40-30-10 <input type="checkbox"/> 1SBL 32 1001 R8 <input type="checkbox"/> 10	A 26-30-01 <input type="checkbox"/> 1SBL 24 1001 R8 <input type="checkbox"/> 01	A 40-30-01 <input type="checkbox"/> 1SBL 32 1001 R8 <input type="checkbox"/> 01	TA 42 DU 42 1SAZ 31 1201 R1003	C	
85 80	A 50-30-00 <input type="checkbox"/> 1SBL 35 1001 R8 <input type="checkbox"/> 00	A 30-30-01 <input type="checkbox"/> 1SBL 28 1001 R8 <input type="checkbox"/> 01	A 50-30-00 <input type="checkbox"/> 1SBL 35 1001 R8 <input type="checkbox"/> 00	TA 75 DU 52 1SAZ 32 1201 R1004	D	
105 96	A 63-30-00 <input type="checkbox"/> 1SBL 37 1001 R8 <input type="checkbox"/> 00	A 40-30-01 <input type="checkbox"/> 1SBL 32 1001 R8 <input type="checkbox"/> 01	A 63-30-00 <input type="checkbox"/> 1SBL 37 1001 R8 <input type="checkbox"/> 00	TA 75 DU 63 1SAZ 32 1201 R1005	D	
119 – – 126	A 75-30-00 <input type="checkbox"/> 1SBL 41 1001 R8 <input type="checkbox"/> 00	A 50-30-00 <input type="checkbox"/> 1SBL 35 1001 R8 <input type="checkbox"/> 00	A 75-30-00 <input type="checkbox"/> 1SBL 41 1001 R8 <input type="checkbox"/> 00	TA 75 DU 80 1SAZ 32 1201 R1006	E	
140 – – 135	A 95-30-00 <input type="checkbox"/> 1SFL 43 1001 R8 <input type="checkbox"/> 00	A 75-30-00 <input type="checkbox"/> 1SFL 41 1001 R8 <input type="checkbox"/> 00	A 95-30-00 <input type="checkbox"/> 1SFL 43 1001 R8 <input type="checkbox"/> 00	TA 110 DU 90 1SAZ 41 1201 R1001	F	
170 – – 182	A 110-30-00 <input type="checkbox"/> 1SFL 45 1001 R8 <input type="checkbox"/> 00	A 95-30-00 <input type="checkbox"/> 1SFL 43 1001 R8 <input type="checkbox"/> 00	A 110-30-00 <input type="checkbox"/> 1SFL 45 1001 R8 <input type="checkbox"/> 00	TA 110 DU 110 1SAZ 41 1201 R1002	G	

(1) The setting current value is : motor rated current  $I_n$  x 0.58.

### Required accessories

Ref. letter	Connection set Type Order code	KM1 Aux. contacts Type Order code	KM2 Aux. Contacts Type Order code	KM3 Aux. Contacts Type Order code	Timer Type Order code	Plate Type Order code
A	BED 16.1 1SBN 08 1403 R1001					
B	BED 26.1 1SBN 08 2403 R1001	CA 5-10 1SBN 01 0010 R1010	CA 5-10 1SBN 01 0010 R1010	–		–
C	BED 40.1 1SBN 08 2803 R1001					
D	BED 50.1 1SBN 08 3503 R1001	2 x CA 5-10 1SBN 01 0010 R1010	CA 5-10 1SBN 01 0010 R1010	CA 5-01 1SBN 01 0010 R1001		–
E	BED 75.1 1SBN 08 4103 R1001		1 x CA 5-10			–
F	BED 95 1 SFN 08 4303 R1000	2 x CA 5-10 1SBN 01 0010 R1010	1SBN 01 0010 R1010 1 x CA 5-01	CA 5-01 1SBN 01 0010 R1001		PN110-41 1 SFN 09 4303 R1000
G	BED 110 1 SFN 08 4503 R1000		1SBN 01 0010 R1001			PN110-41 1 SFN 09 4303 R1000

According to the control voltage (50/60Hz)

24 V **TE5S-24**  
**1SBN 02 0010R1001**  
110...120 V **TE5S-120**  
**1SBN 02 0010R1002**  
220...240 V **TE5S-240**  
**1SBN 02 0010R1003**  
380...440 V **TE5S-440**  
**1SBN 02 0010R1004**

Other Version:

- starter c/w mechanical interlocking, please consult us.

>> Contactor technical data ..... page 32  
>> Accessories ..... page 10

>> Thermal O/L relays ..... page 14  
>> Dimensions and wiring diagrams ..... page 51

# Open Type Reversing Contactors – a.c. Coil VOA 9-30M ... VOA 40-30M

## Ordering Details

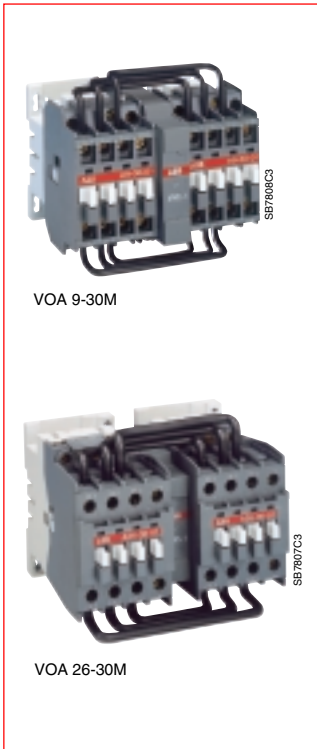

**Reversing Contactors**, factory-assembled, c/w mechanical interlocking and power connections.

Rated operational current AC-3 380 V 400 V 415 V A	Type	Order code	Weight kg
	State coil voltage: <input type="text"/>	to be completed with coil voltage code: <input type="checkbox"/>	Pack <sup>ing</sup> 1 piece
9	VOA 9-30M <input type="text"/>	1SBK 14 1600 R8 <input type="checkbox"/> 00	0.940
12	VOA 12-30M <input type="text"/>	1SBK 16 1600 R8 <input type="checkbox"/> 00	0.940
17	VOA 16-30M <input type="text"/>	1SBK 18 1600 R8 <input type="checkbox"/> 00	0.940
26	VOA 26-30M <input type="text"/>	1SBK 24 1600 R8 <input type="checkbox"/> 00	1.470
32	VOA 30-30M <input type="text"/>	1SBK 28 1600 R8 <input type="checkbox"/> 00	1.710
37	VOA 40-30M <input type="text"/>	1SBK 32 1600 R8 <input type="checkbox"/> 00	1.720

The hold-in function, if necessary, will be carried out with the help of CA 5-10 type N.O. auxiliary contacts (1 on each contactor) to be supplied separately (see page 27).

### Coil voltages and codes

Voltage (V) 50 Hz : <input type="text"/>	Voltage (V) 60 Hz : <input type="text"/>	Coil voltage code : <input type="checkbox"/>
24	24	<input type="checkbox"/> 1
48	48	<input type="checkbox"/> 3
110	110...120	<input type="checkbox"/> 4
220 ... 230	230...240	<input type="checkbox"/> 0
380 ... 400	400...415	<input type="checkbox"/> 5

The control circuit is to be wired when putting the reversing contactor into service.

### Reversing contactors, in kit form

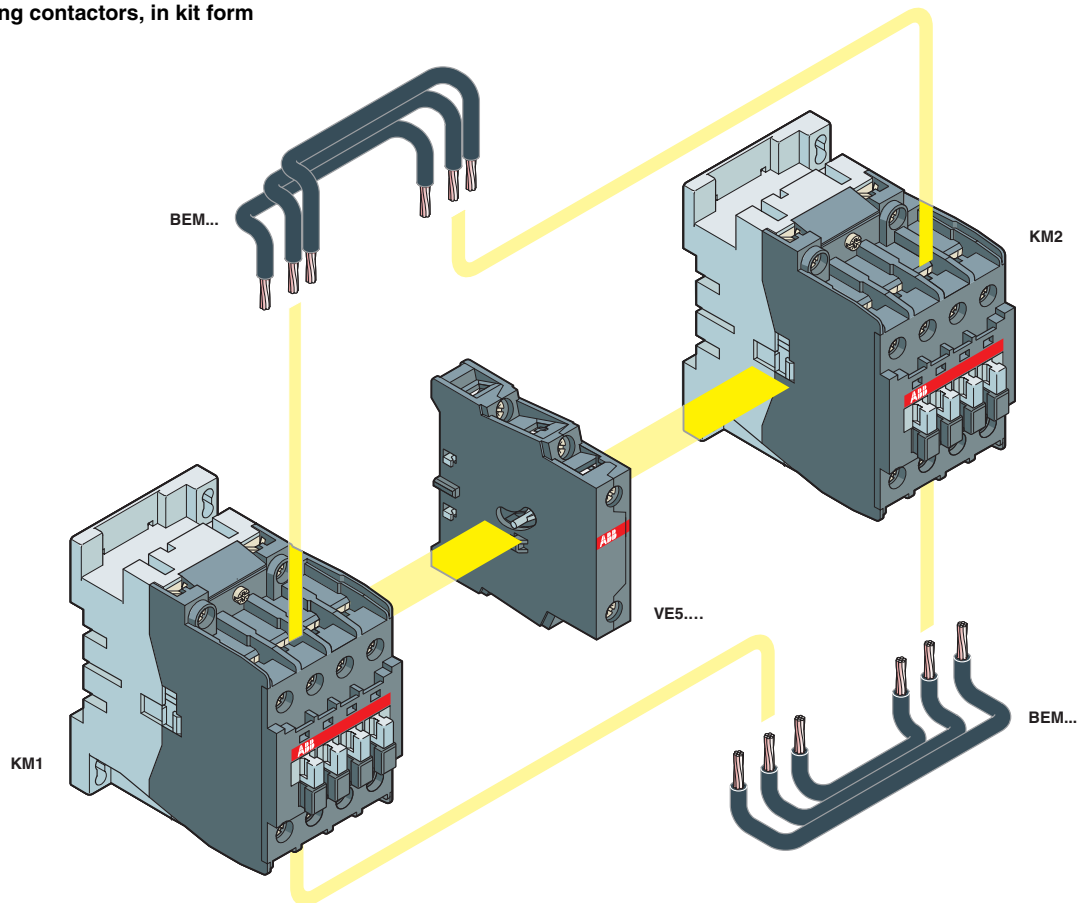

E1119D2

# Open Type Reversing Contactors – a.c. Coil in Kit Form

## Ordering Details

### Components for Reversing Contactors, in kit form

Rated operational current AC-3 380 V 400 V 415 V A	KM1 + KM2 contactors (1)	Interlocking	Connection set
	Type, state coil voltage: [ ] Order code, to be completed with coil voltage code: [ ]	Type Order code	Type Order code
9	2 x A 9-30-10 [ ] 1SBL 14 1001 R8 [ ] 10	1 x VE 5-1 1SBN 03 0110 R1000	1 x BEM 16-30 1SBN 08 1401 R1000
12	2 x A 12-30-10 [ ] 1SBL 16 1001 R8 [ ] 10		
17	2 x A 16-30-10 [ ] 1SBL 18 1001 R8 [ ] 10		1 x BEM 26-30 1SBN 08 2401 R1000
26	2 x A 26-30-10 [ ] 1SBL 24 1001 R8 [ ] 10		
32	2 x A 30-30-10 [ ] 1SBL 28 1001 R8 [ ] 10	1 x VE 5-2 1SBN 03 0210 R1000	1 x BEM 40-30 1SBN 08 2801 R1000
37	2 x A 40-30-10 [ ] 1SBL 32 1001 R8 [ ] 10		1 x BEM 110-30 1SBN 08 4301 R1000
96	2 x A 95-30-00 [ ] 1SFL 43 1001 R8 [ ] 00		
110	2 x A 110-30-00 [ ] 1SFL 45 1001 R8 [ ] 00		

(1) On each A9 ... A40 contactor, one N.O. built-in auxiliary contact is available for the hold-in function.

### Auxiliary Contact Blocks

Positioning	Contacts 	Type	Order code	Pack <sup>ing</sup>	Weight
				pieces	kg
Front	1 -	CA 5-10	1SBN 01 0010 R1010	10	0.014
	- 1	CA 5-01	1SBN 01 0010 R1001	10	0.014
	3 1	CA 5-31M	1SBN 01 0040 R1131	2	0.060
	2 2	CA 5-22M	1SBN 01 0040 R1122	2	0.060
Side	1 1	CAL 5-11	1SBN 01 0020 R1011	2	0.050



### Function Markers

Description	Type	Order code	Pack <sup>ing</sup> box	Weight kg
Box of 50 pieces	BA 5-50	1SBN 11 0000 R1000	1	0.090

# Open Type Changeover Contactors – a.c. Coil VOA..-40Z

## Ordering Details

**Changeover Contactors**, factory-assembled, c/w mechanical interlocking.  
Power connection set to be ordered separately (see table below).

Rated operational current AC-1 $\theta \leq 40^\circ\text{C}$ A	Mounted aux. contacts	Type	Order code	Weight kg	Packing
	 	state coil voltage: <input type="text"/>	to be completed with coil voltage code: <input type="checkbox"/>		1 piece
70	– –	VOA 45-40Z <input type="text"/>	1SBK 33 1900 R8 <input type="checkbox"/> 00	3.020	
100	– –	VOA 50-40Z <input type="text"/>	1SBK 35 1900 R8 <input type="checkbox"/> 00	3.020	
125	– –	VOA 75-40Z <input type="text"/>	1SBK 41 1900 R8 <input type="checkbox"/> 00	3.020	

## Connection Set

Connection utilization	Type	Order code	Weight kg	Packing
				1 set
Coupling for the downstream terminals	BES 75-40	1SBN 08 3302 R1000	0.400	

## Coil voltages and codes

Voltage (V) 50 Hz : <input type="text"/>	Voltage (V) 60 Hz : <input type="text"/>	Coil voltage code : <input type="checkbox"/>
24	24	<input type="checkbox"/> 1
48	48	<input type="checkbox"/> 3
110	110...120	<input type="checkbox"/> 4
220 ... 230	230...240	<input type="checkbox"/> 0
380 ... 400	400...415	<input type="checkbox"/> 5

The control circuit is to be wired when putting the changeover contactor into service.

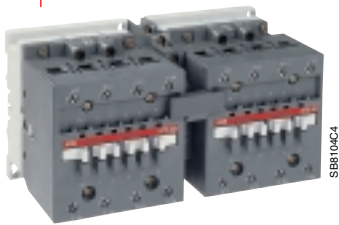

VOA 75-40Z

SB8104C4

## Changeover contactors, in kit form

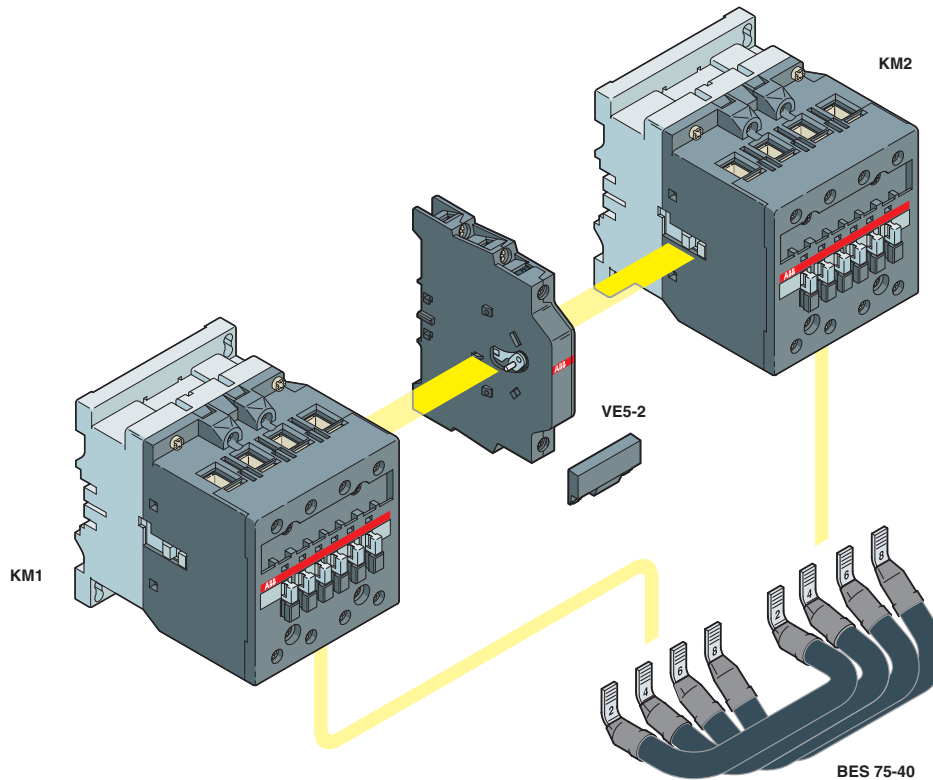

E1106D3

# Open Type Changeover Contactors – a.c. Coil in Kit Form

## Ordering Details

### Components for Changeover Contactors, in kit form

Rated operational current <b>AC-1</b> $\theta \leq 40\text{ }^{\circ}\text{C}$ <b>A</b>	<b>KM1 + KM2 Contactors</b>	<b>Interlocking</b>	<b>Connection set</b>
	Type, state coil voltage: <input type="checkbox"/> Order code, to be completed with coil voltage code: <input type="checkbox"/>	Type Order code	Type Order code
70	2 x A 45-40-00 <input type="checkbox"/> 1SBL 33 1201 R8 <input type="checkbox"/> 00	1 x VE 5-2 1SBN 03 0210 R1000	1 x BES 75-40 1SBN 08 3302 R1000
100	2 x A 50-40-00 <input type="checkbox"/> 1SBL 35 1201 R8 <input type="checkbox"/> 00		
125	2 x A 75-40-00 <input type="checkbox"/> 1SBL 41 1201 R8 <input type="checkbox"/> 00		

### Auxiliary Contacts Blocks

Positioning	Contacts 	Type	Order code	Pack <sup>ing</sup>	Weight
				pieces	kg
Front	1 -	CA 5-10	1SBN 01 0010 R1010	10	0.014
	- 1	CA 5-01	1SBN 01 0010 R1001	10	0.014
	4 -	CA 5-40E	1SBN 01 0040 R1040	2	0.060
	2 2	CA 5-22E	1SBN 01 0040 R1022	2	0.060
Side	1 1	CAL 5-11	1SBN 01 0020 R1011	2	0.050

### Function Markers

Description	Type	Order code	Pack <sup>ing</sup> box	Weight kg
Box of 50 pieces	BA 5-50	1SBN 11 0000 R1000	1	0.090

### Auxiliary Lead Terminals

Connection	Type	Order code	Pack <sup>ing</sup> pieces	Weight kg
Right/left	LK 75-L	1SBN 07 3552 R1003	2	0.006
Front	LK 75-F	1SBN 07 3552 R1002	2	0.006

# Contact Sets - Coils

## Ordering Details

### Contact Sets

For contactor :	Type	Order code	Pack <sup>ing</sup> set	Weight kg
3 -pole	A 50	ZL 50	1SBN 16 3503 R1000	1 0.115
	A 63	ZL 63	1SBN 16 3703 R1000	1 0.130
	A 75	ZL 75	1SBN 16 4103 R1000	1 0.145
	A 95	ZL 95	1SFN 16 4303 R1000	1 0.190
	A 110	ZL 110	1SFN 16 4503 R1000	1 0.190
	A 145	ZL 145	1SFN 16 4703 R1000	1 0.380
	A 185	ZL 185	1SFN 16 4903 R1000	1 0.380
	A 210	ZL 210	1SFN 16 5103 R1000	1 0.670
	A 260	ZL 260	1SFN 16 5303 R1000	1 0.670
	A 300	ZL 300	1SFN 16 5503 R1000	1 0.670
4 -pole	AF 400	ZL 400	1SFN 16 5703 R1000	1 1.320
	AF 460	ZL 460	1SFN 16 5903 R1000	1 1.320
	AF 580	ZL 580	1SFN 16 6103 R1000	1 1.840
	AF 750	ZL 750	1SFN 16 6303 R1000	1 1.840
	A 45	ZLT 45	1SBN 16 3304 R1000	1 0.150
	A 50	ZLT 50	1SBN 16 3504 R1000	1 0.150
	A 75	ZLT 75	1SBN 16 4104 R1000	1 0.160
	EK 110	KZK 110	SK 824 204-A	1 0.450
	EK 150	KZK 150	SK 824 204-B	1 0.450
	EK 175	KZK 175	SK 825 204-A	1 0.700
EK 210	KZK 210	SK 825 204-B	1 0.700	
EK 370	KZK 370	SK 827 204-A	1 2.400	
EK 550	KZK 550	SK 827 204-B	1 2.400	
EK 1000	KZK 1000	SK 827 204-F	1 2.400	

### Coils

For contactor :	Type	Order code	Pack <sup>ing</sup> piece	Weight kg
	State coil voltage: <input type="checkbox"/> <input type="checkbox"/>	coil voltage code see table below: <input type="checkbox"/> <input type="checkbox"/>		
3 -pole	A 9 ... A 16	ZA 16 <input type="checkbox"/>	1SBN 15 1410 R <input type="checkbox"/> <input type="checkbox"/> 06	1 0.093
	A 26 ... A 40	ZA 40 <input type="checkbox"/>	1SBN 15 2410 R <input type="checkbox"/> <input type="checkbox"/> 06	1 0.148
	A 50 ... A 75	ZA 75 <input type="checkbox"/>	1SBN 15 3510 R <input type="checkbox"/> <input type="checkbox"/> 06	1 0.166
	A 95 ... A 110	ZA 110 <input type="checkbox"/>	1SFN 15 4310 R <input type="checkbox"/> <input type="checkbox"/> 06	1 0.195
	A 145, A 185	ZA 185 <input type="checkbox"/>	1SFN 15 4710 R <input type="checkbox"/> <input type="checkbox"/> 06	1 0.180
4 -pole	A 210 ... A 300	ZA 300 <input type="checkbox"/>	1SFN 15 5110 R <input type="checkbox"/> <input type="checkbox"/> 06	1 0.410
	AF 400, AF 460	ZAF 460 <input type="checkbox"/>	1SFN 15 5770 R <input type="checkbox"/> <input type="checkbox"/> 06	1 0.525
	AF 580, AF 750	ZAF 750 <input type="checkbox"/>	1SFN 15 6170 R <input type="checkbox"/> <input type="checkbox"/> 06	1 1.335
	A 9 ... A 16	ZA 16 <input type="checkbox"/>	1SBN 15 1410 R <input type="checkbox"/> <input type="checkbox"/> 06	1 0.093
	A 26	ZA 40 <input type="checkbox"/>	1SBN 15 2410 R <input type="checkbox"/> <input type="checkbox"/> 06	1 0.148
	A 45, A 75	ZA 75 <input type="checkbox"/>	1SBN 15 3510 R <input type="checkbox"/> <input type="checkbox"/> 06	1 0.166
	EK 110, EK 150	KH 210 <input type="checkbox"/>	SK 825 400 - <input type="checkbox"/> <input type="checkbox"/>	1 0.360
	EK 175, EK 210	KH 300 <input type="checkbox"/>	SK 826 400 - <input type="checkbox"/> <input type="checkbox"/>	1 0.440
	EK 370 ... EK 1000	KH 800 <input type="checkbox"/>	SK 828 100 - <input type="checkbox"/> <input type="checkbox"/>	1 0.950
	Cont. relay N	ZA 16 <input type="checkbox"/>	1 SBN 15 1410 R <input type="checkbox"/> <input type="checkbox"/> 06	1 0.093

#### Coil voltages and codes: A9 ... A300 and N..

Voltage (V) 50 Hz : <input type="checkbox"/>	Voltage (V) 60 Hz : <input type="checkbox"/>	Voltage code : <input type="checkbox"/> <input type="checkbox"/>
24	24	<input type="checkbox"/> <input type="checkbox"/> 1
48	48	<input type="checkbox"/> <input type="checkbox"/> 3
110	110...120	<input type="checkbox"/> <input type="checkbox"/> 4
220 ... 230	230...240	<input type="checkbox"/> <input type="checkbox"/> 0
230 ... 240	240...260	<input type="checkbox"/> <input type="checkbox"/> 8
380 ... 400	400...415	<input type="checkbox"/> <input type="checkbox"/> 5
400 ... 415	415...440	<input type="checkbox"/> <input type="checkbox"/> 6

Other voltages : page 36.

#### Coil voltages and codes: EK 110 ... EK 1000

Voltage (V) 50 Hz : <input type="checkbox"/>	Voltage (V) 60 Hz : <input type="checkbox"/>	Voltage code : <input type="checkbox"/> <input type="checkbox"/>
48	-	<input type="checkbox"/> <input type="checkbox"/> A <input type="checkbox"/> <input type="checkbox"/> D
-	110	<input type="checkbox"/> <input type="checkbox"/> A <input type="checkbox"/> <input type="checkbox"/> E
110	120	<input type="checkbox"/> <input type="checkbox"/> A <input type="checkbox"/> <input type="checkbox"/> F
220 ... 230	-	<input type="checkbox"/> <input type="checkbox"/> A <input type="checkbox"/> <input type="checkbox"/> L
230 ... 240	-	<input type="checkbox"/> <input type="checkbox"/> A <input type="checkbox"/> <input type="checkbox"/> M
-	380	<input type="checkbox"/> <input type="checkbox"/> A <input type="checkbox"/> <input type="checkbox"/> N
380 ... 400	440	<input type="checkbox"/> <input type="checkbox"/> A <input type="checkbox"/> <input type="checkbox"/> P
400 ... 415	-	<input type="checkbox"/> <input type="checkbox"/> A <input type="checkbox"/> <input type="checkbox"/> R

Other voltages : page 37.

#### Coil voltages and codes: AF 400 ... AF 750

Voltage (V) 50 Hz : <input type="checkbox"/>	Voltage (V) 60 Hz : <input type="checkbox"/>	Voltage code : <input type="checkbox"/> <input type="checkbox"/>
-	24 ... 60	<input type="checkbox"/> <input type="checkbox"/> 6 <input type="checkbox"/> <input type="checkbox"/> 8
48 ... 130	48 ... 130	<input type="checkbox"/> <input type="checkbox"/> 6 <input type="checkbox"/> <input type="checkbox"/> 9
100 ... 250	100 ... 250	<input type="checkbox"/> <input type="checkbox"/> 7 <input type="checkbox"/> <input type="checkbox"/> 0

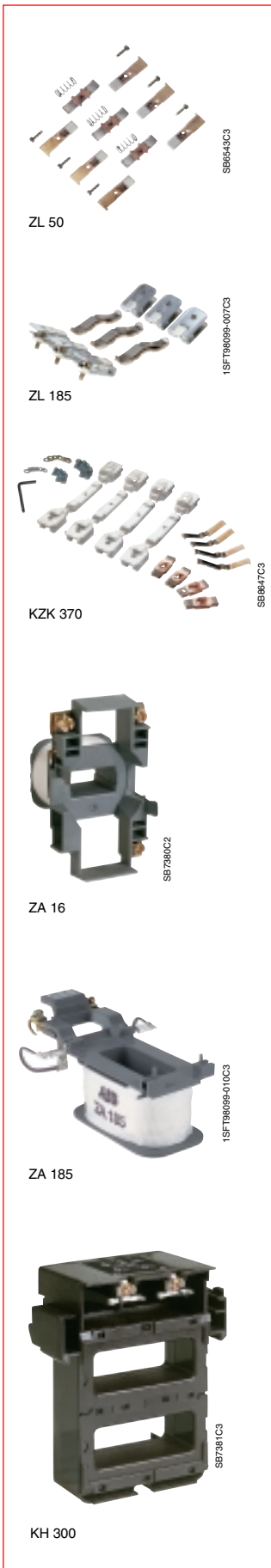

# Motor Rating and Rated Current

The currents shown in the table below are those given for standard three phase squirrel-cage motors. 1500 r.p.m. 50 Hz. Values quoted are for guidance only, they can vary depending on the number of poles and design.

Motor rating		Motor rated current at :							
		220-230 V	240 V	380 V 380-400 V	415 V	440 V	500 V	600 V	660-690 V
kW	PS = hp	A	A	A	A	A	A	A	A
0.06	1/12	0.38	0.35	0.22	0.20	0.19	0.16	0.12	–
0.09	1/8	0.55	0.50	0.33	0.30	0.28	0.24	0.21	–
0.12	1/6	0.76	0.68	0.42	0.40	0.37	0.33	0.27	–
0.18	1/4	1.1	1	0.64	0.60	0.55	0.46	0.40	–
0.25	1/3	1.4	1.38	0.88	0.85	0.76	0.59	0.56	–
0.37	1/2	2.1	1.93	1.22	1.15	1.06	0.85	0.77	0.7
0.55	3/4	2.7	2.3	1.5	1.40	1.25	1.20	1.02	0.9
0.75	1	3.3	3.1	2	2	1.67	1.48	1.22	1.1
1.1	1.5	4.9	4.1	2.6	2.5	2.26	2.1	1.66	1.5
1.5	2	6.2	5.6	3.5	3.5	3.03	2.6	2.22	2
2.2	3	8.7	7.9	5	5	4.31	3.8	3.16	2.9
2.5	3.4	9.8	8.9	5.7	5.5	4.9	4.3	3.59	3.3
3	4	11.6	10.6	6.6	6.5	5.8	5.1	4.25	3.5
3.7	5	14.2	13	8.2	7.5	7.1	6.2	5.2	4.4
4	5.5	15.3	14	8.5	8.4	7.6	6.5	5.6	4.9
5	6.8	18.9	17.2	10.5	10	9.4	8.1	6.9	6
5.5	7.5	20.6	18.9	11.5	11	10.3	8.9	7.5	6.7
6.5	8.8	23.7	21.8	13.8	12.5	12	10.4	8.7	8.1
7.5	10	27.4	24.8	15.5	14	13.5	11.9	9.9	9
8	11	28.8	26.4	16.7	15.4	14.4	12.7	10.6	9.7
9	12.5	32	29.3	18.3	17	15.8	13.9	11.6	10.6
11	15	39.2	35.3	22	21	19.3	16.7	14.1	13
12.5	17	43.8	40.2	25	23	21.9	19	16.1	15
15	20	52.6	48.2	30	28	26.3	22.5	19.3	17.5
18.5	25	64.9	58.7	37	35	32	28.5	23.5	21
20	27	69.3	63.4	40	37	34.6	30.6	25.4	23
22	30	75.2	68	44	40	37.1	33	27.2	25
25	34	84.4	77.2	50	47	42.1	38	30.9	28
30	40	101	92.7	60	55	50.1	44	37.1	33
37	50	124	114	72	66	61.9	54	45.4	42
40	54	134	123	79	72	67	60	49.1	44
45	60	150	136	85	80	73.9	64.5	54.2	49
51	70	168	154	97	90	83.8	73.7	61.4	56
55	75	181	166	105	96	90.3	79	66.2	60
59	80	194	178	112	105	96.9	85.3	71.1	66
75	100	245	226	140	135	123	106	90.3	82
80	110	260	241	147	138	131	112	96.3	86
90	125	292	268	170	165	146	128	107	98
100	136	325	297	188	182	162	143	119	107
110	150	358	327	205	200	178	156	131	118
129	175	420	384	242	230	209	184	153	135
132	180	425	393	245	242	214	186	157	140
140	190	449	416	260	250	227	200	167	145
147	200	472	432	273	260	236	207	173	152
160	220	502	471	295	280	256	220	188	170
180	245	578	530	333	320	289	254	212	190
184	250	590	541	340	325	295	259	217	200
200	270	626	589	370	340	321	278	235	215
220	300	700	647	408	385	353	310	260	235
250	340	803	736	460	425	401	353	295	268
257	350	826	756	475	450	412	363	302	280
295	400	948	868	546	500	473	416	348	320
315	430	990	927	580	535	505	445	370	337
355	480	1080	1010	636	580	549	483	405	366
400	545	1250	1130	710	650	611	538	450	410
450	610	1410	1270	800	740	688	608	508	460
475	645	1490	1340	850	780	730	645	540	485
500	680	1570	1420	890	830	770	680	565	510
560	760	1750	1580	1000	920	860	760	630	570
600	810	–	–	1080	990	920	810	680	610
670	910	–	–	1200	1100	1030	910	760	680

# Technical Data

## A9 ... A110 3-pole Contactors

### A.. 3-pole Contactors

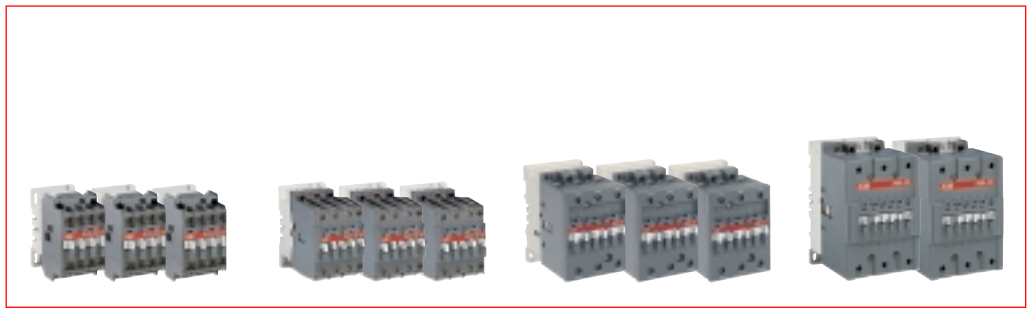

#### Types

	A9	A12	A16	A26	A30	A40	A50	A63	A75	A95	A110	
<b>Rated operational current I<sub>e</sub> / AC-3</b>												
220-230-240 V	A	9	12	17	26	33	40	53	65	75	96	110
380-400 V	A	9	12	17	26	32	37	50	65	75	96	110
for air temperature around the contactor : θ ≤ 55 °C	A	9	12	16	26	32	37	45	65	70	93	100
415 V	A	9	12	14	22	28	33	45	55	65	80	100
440 V	A	9	12	16	26	32	37	45	65	70	93	100
500 V	A	9	12	14	22	28	33	45	55	65	80	100
690 V	A	7	9	10	17	21	25	35	43	46	65	82
1000 V	A	-	-	-	-	-	-	23	25	28	30	30
<b>Rated operational current I<sub>e</sub> / AC-1</b>												
θ ≤ 40 °C	A	25	27	30	45	55	60	100	115	125	145	160
θ ≤ 55 °C	A	22	25	27	40	55	60	85	95	105	135	145
θ ≤ 70 °C	A	18	20	23	32	39	42	70	80	85	115	130
with connecting cross-section	mm <sup>2</sup>	2.5	4	4	6	10	16	35	50	50	50	70
rated operational voltage U <sub>e</sub> max.	V	690	690	690	690	690	690	690	690	690	690	690
<b>Max. back-up fuse gG</b>	A	25	32	32	50	63	63	100	125	160	160	200
<b>Fixing</b>	See fixing details and dimensions page 51											
<b>Connecting terminals</b>	Cable clamp      Cable clamp      Double cable connector      Single cable connector      Single cable connector											
<b>Connecting capacity</b>												
Main conductors (poles)												
Rigid solid (≤ 4 mm <sup>2</sup> ) or rigid stranded (≥ 6 mm <sup>2</sup> )	1x mm <sup>2</sup>	1 ... 4	1 ... 4	1 ... 4	1.5 ... 6	1.5 ... 6	2.5 ... 16	2.5 ... 16	6 ... 50	6 ... 16	10 ... 95	10 ... 35
	2x mm <sup>2</sup>	1 ... 4	1 ... 4	1 ... 4	1.5 ... 6	1.5 ... 6	2.5 ... 16	2.5 ... 16	6 ... 16	6 ... 16	6 ... 35	6 ... 35
Flexible with cable end	1x mm <sup>2</sup>	0.75 ... 2.5	0.75 ... 2.5	0.75 ... 2.5	0.75 ... 4	0.75 ... 4	2.5 ... 10	2.5 ... 10	6 ... 35	6 ... 25	10 ... 70	6 ... 35
	2x mm <sup>2</sup>	0.75 ... 2.5	0.75 ... 2.5	0.75 ... 2.5	0.75 ... 4	0.75 ... 4	2.5 ... 10	2.5 ... 10	6 ... 25	6 ... 25	6 ... 35	6 ... 35
Bars or lugs :												
max. width	mm ≤	8	8	8	10	10	-	-	-	-	-	-
hole Ø	mm >	3.7	3.7	3.7	4.2	4.2	-	-	-	-	-	-
Auxiliary conductors												
Rigid solid	1x mm <sup>2</sup>	1 ... 4	1 ... 4	1 ... 4	1 ... 4	1 ... 4	1 ... 4	1 ... 4	1 ... 4	1 ... 4	0.75 ... 2.5	0.75 ... 2.5
	2x mm <sup>2</sup>	1 ... 4	1 ... 4	1 ... 4	1 ... 4	1 ... 4	1 ... 4	1 ... 4	1 ... 4	1 ... 4	0.75 ... 2.5	0.75 ... 2.5
Flexible with cable end	1x mm <sup>2</sup>	0.75 ... 2.5	0.75 ... 2.5	0.75 ... 2.5	0.75 ... 2.5	0.75 ... 2.5	0.75 ... 2.5	0.75 ... 2.5	1 ... 2.5	0.75 ... 2.5	0.75 ... 2.5	0.75 ... 2.5
	2x mm <sup>2</sup>	0.75 ... 2.5	0.75 ... 2.5	0.75 ... 2.5	0.75 ... 2.5	0.75 ... 2.5	0.75 ... 2.5	0.75 ... 2.5	0.75 ... 2.5	0.75 ... 2.5	0.75 ... 2.5	0.75 ... 2.5
<b>Degree of protection of terminals</b>	All terminals IP 20      All terminals IP 20      Main terminals IP 10      Auxiliary terminals IP 20											
<b>Coil consumption</b>												
50 Hz pull-in	VA	70	70	70	120	120	120	180	180	180	350	350
50 Hz holding	VA/W	8/2	8/2	8/2	12/3	12/3	12/3	18/5.5	18/5.5	18/5.5	22/6.5	22/6.5

#### Built-in or Add-on Auxiliary Contacts

<b>Rated operational current I<sub>e</sub> / AC-15</b>	24 ... 127 V : 6 A	220 ... 240 V : 4 A	380 ... 440 V : 3 A
<b>Max. back-up fuse gG</b>	10 A		
<b>Min. switching capacity</b>	17 V / 5 mA		

>> Dimensions ..... page 51



# Technical Data

## A 145 ... AF 750 3-pole Contactors

### A., AF.. 3-pole Contactors

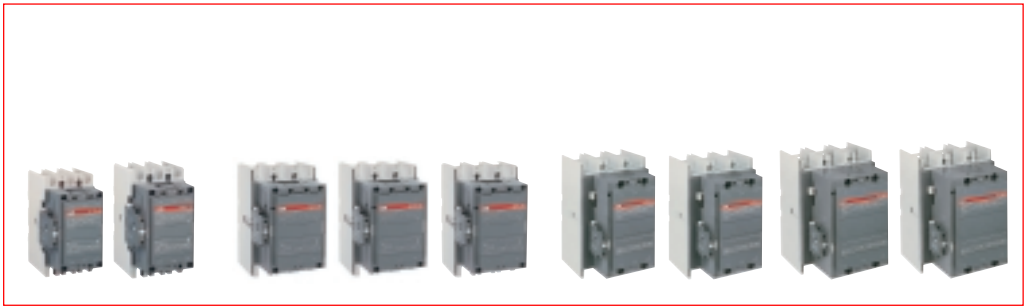

#### Types

**A 145**
**A 185**
**A 210**
**A 260**
**A 300**
**AF 400**
**AF 460**
**AF 580**
**AF 750**

#### Rated operational current $I_e$ / AC-3

220-230-240 V	<b>A</b>	145	185	210	260	305	400	460	580	750
<b>380-400 V</b>	<b>A</b>	<b>145</b>	<b>185</b>	<b>210</b>	<b>260</b>	<b>305</b>	<b>400</b>	<b>460</b>	<b>580</b>	<b>750</b>
415 V	<b>A</b>	145	185	210	260	300	400	460	580	750
for air temperature around the contactor :	<b>A</b>	145	185	210	240	280	400	460	580	750
$\theta \leq 55^\circ\text{C}$	<b>A</b>	145	170	210	240	280	400	460	580	750
690 V	<b>A</b>	120	170	210	220	280	350	400	500	650
-	-	-	-	-	-	-	-	-	-	-

#### Rated operational current $I_e$ / AC-1

for air temperature around the contactor :	$\theta \leq 40^\circ\text{C}$	<b>A</b>	<b>250</b>	<b>275</b>	<b>350</b>	<b>400</b>	<b>500</b>	<b>600</b>	<b>700</b>	<b>800</b>	<b>1050</b>
	$\theta \leq 55^\circ\text{C}$	<b>A</b>	230	250	300	350	400	500	600	700	800
	$\theta \leq 70^\circ\text{C}$	<b>A</b>	180	180	240	290	325	400	480	580	720
with connecting cross-section	<b>mm<sup>2</sup></b>	120	150	185	240	300	2 x 185	2 x 240	2 x 240	-	-
with bar dimensions	<b>mm</b>	-	-	-	-	-	-	-	-	-	2 x 80 x 5
rated operational voltage $U_e$ max.	<b>V</b>	690	690	690	690	690	690	690	690	690	690
<b>Max. back-up fuse gG</b>	<b>A</b>	315	355	400	500	500	630	800	1000	1000	-

#### Fixing

See fixing details and dimensions page 51

#### Connecting terminals

 Flat type  $c/w$  screws and bolts

#### Connecting capacity

##### Main conductors (poles)

##### Rigid with connector :

- single for Cu cable	<b>mm<sup>2</sup></b>	6 ... 185	16 ... 240	240	300
- single for Al/Cu cable	<b>mm<sup>2</sup></b>	25 ... 150	120 ... 240	240	300
- double for Al/Cu cable	<b>mm<sup>2</sup></b>	-	2 x (95 ... 120)	2 x 240	3 x 185

##### Bars or lugs :

max. width	<b>mm <math>\leq</math></b>	24	32	47/45	52/50
hole $\varnothing$	<b>mm <math>&gt;</math></b>	8	10	10	12

##### Auxiliary conductors

Rigid solid	<b>1 x mm<sup>2</sup></b>	1 ... 4
	<b>2 x mm<sup>2</sup></b>	1 ... 4
Flexible with cable end	<b>1 x mm<sup>2</sup></b>	0.75 ... 2.5
	<b>2 x mm<sup>2</sup></b>	0.75 ... 2.5

#### Degree of protection of terminals

Main terminals IP 00 - Auxiliary terminals IP 20

#### Coil consumption

50 Hz pull-in	<b>VA</b>	550	1350	890	850
50 Hz holding	<b>VA/W</b>	35/11	60/16	12/4	12/4.5

#### Add-on Auxiliary Contacts

#### Rated operational current $I_e$ / AC-15

24 ... 127 V : 6 A    220 ... 240 V : 4 A    380 ... 440 V : 3 A

#### Max. back-up fuse gG

10 A

#### Min. switching capacity

17 V / 5 mA

# Technical Data

## A9 ... A75 4-pole Contactors

### A.. 4-pole Contactors

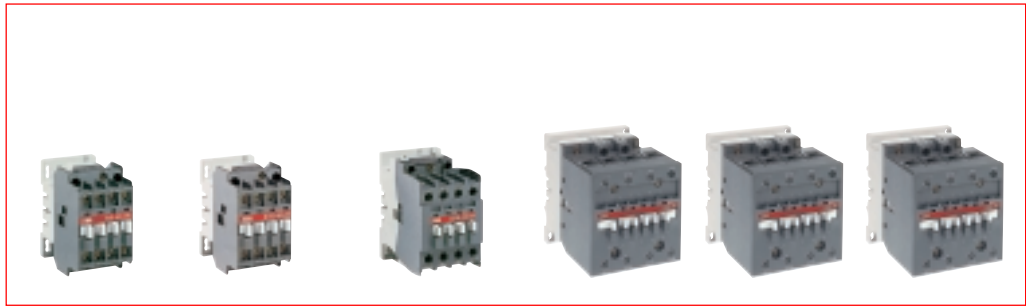

#### Types

##### Rated operational current $I_e$ / AC-1

for air temperature  $\theta \leq 40^\circ\text{C}$  **A**  
 around the contactor :  $\theta \leq 55^\circ\text{C}$  **A**  
 $\theta \leq 70^\circ\text{C}$  **A**  
 with connecting cross-section **mm<sup>2</sup>**  
 rated operational voltage  $U_e$  max. **V**

**Max. back-up fuse gG** **A**

##### Fixing

##### Connecting terminals

##### Connecting capacity

##### Main conductors (poles)

Rigid solid ( $\leq 4 \text{ mm}^2$ ) or **1 x mm<sup>2</sup>**  
 rigid stranded ( $\geq 6 \text{ mm}^2$ ) **2 x mm<sup>2</sup>**

Flexible with **1 x mm<sup>2</sup>**  
 cable end **2 x mm<sup>2</sup>**

Bars or lugs :  
 max. width **mm  $\leq$**   
 hole  $\varnothing$  **mm  $>$**

##### Auxiliary conductors

Rigid solid **1 x mm<sup>2</sup>**  
**2 x mm<sup>2</sup>**

Flexible with **1 x mm<sup>2</sup>**  
 cable end **2 x mm<sup>2</sup>**

##### Degree of protection of terminals

##### Coil consumption

50 Hz pull-in **VA**  
 50 Hz holding **VA/W**

	A9	A16	A26	A45	A50	A75
<b>Rated operational current <math>I_e</math> / AC-1</b>						
for air temperature $\theta \leq 40^\circ\text{C}$ <b>A</b>	<b>25</b>	<b>30</b>	<b>45</b>	<b>70</b>	<b>100</b>	<b>125</b>
around the contactor : $\theta \leq 55^\circ\text{C}$ <b>A</b>	22	27	40	60	85	105
$\theta \leq 70^\circ\text{C}$ <b>A</b>	18	23	32	50	70	85
with connecting cross-section <b>mm<sup>2</sup></b>	2.5	4	6	25	35	50
rated operational voltage $U_e$ max. <b>V</b>	690	690	690	690	690	690
<b>Max. back-up fuse gG</b> <b>A</b>	25	32	50	80	100	160
<b>Fixing</b>	See fixing details and dimensions page 51					
<b>Connecting terminals</b>	Cable clamp		Cable clamp		Single cable connector	
<b>Connecting capacity</b>						
<b>Main conductors (poles)</b>						
Rigid solid ( $\leq 4 \text{ mm}^2$ ) or <b>1 x mm<sup>2</sup></b>	1 ... 4		1.5 ... 6		6 ... 50	
rigid stranded ( $\geq 6 \text{ mm}^2$ ) <b>2 x mm<sup>2</sup></b>	1 ... 4		1.5 ... 6		6 ... 16	
Flexible with <b>1 x mm<sup>2</sup></b>	0.75 ... 2.5		0.75 ... 4		6 ... 35	
cable end <b>2 x mm<sup>2</sup></b>	0.75 ... 2.5		0.75 ... 4		6 ... 25	
Bars or lugs : max. width <b>mm <math>\leq</math></b>	8		10		-	
hole $\varnothing$ <b>mm <math>&gt;</math></b>	3.7		4.2		-	
<b>Auxiliary conductors</b>						
Rigid solid <b>1 x mm<sup>2</sup></b>	1 ... 4		1 ... 4		1 ... 4	
<b>2 x mm<sup>2</sup></b>	1 ... 4		1 ... 4		1 ... 4	
Flexible with <b>1 x mm<sup>2</sup></b>	0.75 ... 2.5		0.75 ... 2.5		1 ... 2.5	
cable end <b>2 x mm<sup>2</sup></b>	0.75 ... 2.5		0.75 ... 2.5		0.75 ... 2.5	
<b>Degree of protection of terminals</b>	All terminals IP 20		All terminals IP 20		Main terminals IP 10 Auxiliary terminals IP 20	
<b>Coil consumption</b>						
50 Hz pull-in <b>VA</b>	70		120		180	
50 Hz holding <b>VA/W</b>	8/2		12/3		18/5.5	
<b>Add-on Auxiliary Contacts</b>						
<b>Rated operational current <math>I_e</math> / AC-15</b>	24 ... 127 V : 6 A		220 ... 240 V : 4 A		380 ... 440 V : 3 A	
<b>Max. back-up fuse gG</b>	10 A					
<b>Min. switching capacity</b>	17 V / 5 mA					

>> Dimensions ..... page 51

# Technical Data

## EK 110 ... EK 1000 4-pole Contactors

### EK.. 4-pole Contactors

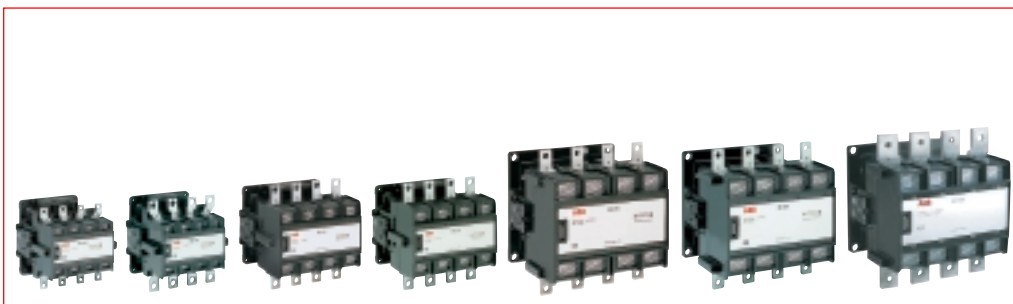

#### Types

**EK 110    EK 150                    EK 175    EK 210                    EK 370                    EK 550                    EK 1000**

#### Rated operational current $I_e$ / AC-1

	$\theta \leq 40^\circ\text{C}$	<b>A</b>	<b>200</b>	<b>250</b>	<b>300</b>	<b>350</b>	<b>550</b>	<b>800</b>	<b>1000</b>
for air temperature	$\theta \leq 55^\circ\text{C}$	<b>A</b>	180	230	270	310	470	650	800
around the contactor :	$\theta \leq 70^\circ\text{C}$	<b>A</b>	155	200	215	250	400	575	720
with connecting cross-section	<b>mm<sup>2</sup></b>		95	150	185	240	2 x 185	2 x 240	2 x 300
rated operational voltage $U_e$ max.	<b>V</b>		690	690	690	690	690	690	690
<b>Max. back-up fuse gG</b>	<b>A</b>		250	250	355	355	630	800	1000

#### Fixing

See fixing details and dimensions page 51

#### Connecting terminals

Flat type c/w screws and bolts

#### Connecting capacity

##### Main conductors (poles)

##### Rigid with connector :

- single for Cu cable	<b>mm<sup>2</sup></b>	25 ... 120	25 ... 185	25 ... 185	70 ... 300	-
- single for Al/Cu cable	<b>mm<sup>2</sup></b>	10 ... 70	35 ... 120	35 ... 120	70 ... 300	95 ... 300
- double for Al/Cu cable	<b>mm<sup>2</sup></b>	-	-	-	2 x (35 ... 185)	2 x (95 ... 300)

##### Bars or lugs :

max. width	<b>mm <math>\leq</math></b>	30	30	33	55	
hole $\varnothing$	<b>mm <math>&gt;</math></b>	6	10	10	10	

##### Auxiliary conductors

Rigid solid	<b>1 x mm<sup>2</sup></b>	0.5 ... 2.5		0.5 ... 2.5		0.5 ... 2.5
	<b>2 x mm<sup>2</sup></b>	0.5 ... 2.5		0.5 ... 2.5		0.5 ... 2.5
Flexible with cable end	<b>1 x mm<sup>2</sup></b>	0.5 ... 2.5		0.5 ... 2.5		0.5 ... 2.5
	<b>2 x mm<sup>2</sup></b>	0.5 ... 2.5		0.5 ... 2.5		0.5 ... 2.5

#### Degree of protection of terminals

Main terminals IP 00 - Auxiliary terminals IP 20

#### Coil consumption

50 Hz pull-in	<b>VA</b>	800		1100		3500
50 Hz holding	<b>VA/W</b>	44/15		52/18		125/50

#### Add-on Auxiliary Contacts

<b>Rated operational current <math>I_e</math> / AC-15</b>	24 ... 127 V : 6 A	220 ... 240 V : 6 A	380 ... 440 V : 4 A
<b>Max. back-up fuse gG</b>	10 A		
<b>Min. switching capacity</b>	0.25 VA / 12 V or 0.25 VA / 5 mA		

>> Dimensions ..... page 51

# Coil Voltages and Codes

## A9 ... A300 Contactors, N.. Contactor Relays

V (50 Hz)	V (60 Hz)	Code □ □
24	24	8 1
26	28	1 6
28	32	1 7
42	42	8 2
48	48	8 3
60	60	7 3
100	100 ... 110	7 4
110	110 ... 120	8 4
110 ... 115	115 ... 127 <sup>(2)</sup>	8 9
120	140	2 9
125 ... 127	150	3 0
175	208	3 4
190	220	3 6
200	200 ... 220	7 5
220 ... 230	230 ... 240	8 0
230 ... 240	240 ... 260	8 8
230 ... 240	277	4 2
230/400 <sup>(1)</sup>	–	6 2
–	230/400 <sup>(1)</sup>	6 3
380 ... 400	400 ... 415	8 5
400 ... 415	415 ... 440	8 6
440	500	5 3
500	600	5 5
550	–	5 6
660 ... 690	–	5 8

(1) Only for A9 ... A16, N

(2) A 145 ... A 300 at 60 Hz 115 V only

## AF 400 ... AF 750 Contactors

V (50 ... 60 Hz)	V (d.c.)	Code □ □
–	24 ... 60	6 8
48 ... 130	48 ... 130	6 9
100 ... 250	100 ... 250	7 0

## Coil Voltages and Codes

### EK 110 ... EK 210 Contactors

V (50 Hz)	V (60 Hz)	Code □ □
–	24	A A
24	–	A B
–	48	A C
48	–	A D
–	110	A E
110	120	A F
–	–	– –
–	–	– –
127	–	A G
–	208	A Z
190	220	A H
–	240	A K
220 ... 230	–	A L
–	–	– –
–	–	– –
230 ... 240	–	A M
–	380	A N
380 ... 400	440	A P
–	–	– –
–	–	– –
400 ... 415	–	A R
–	480	A S
440	–	A T
500	–	A U
–	600	A V

### EK 370 ... EK 1000 Contactors

V (50 Hz)	V (60 Hz)	Code □ □
–	–	– –
–	–	– –
–	–	– –
48	–	A D
–	110	A E
110	120	A F
110	110 ... 120	E F
110 ... 115	115 ... 127	E G
127	–	A G
–	208	A Z
190	220	A H
–	240	A K
220 ... 230	240	A L
220	220 ... 240	E L
220 ... 230	230 ... 255	E M
230 ... 240	–	A M
–	380	A N
380 ... 400	440	A P
380	380 ... 415	E P
380 ... 400	400 ... 440	E R
400 ... 415	–	A R
–	480	A S
440	–	A T
500	–	A U
–	600	A V

# Conversion Tables

## B.., EH.. Series to A.. Series

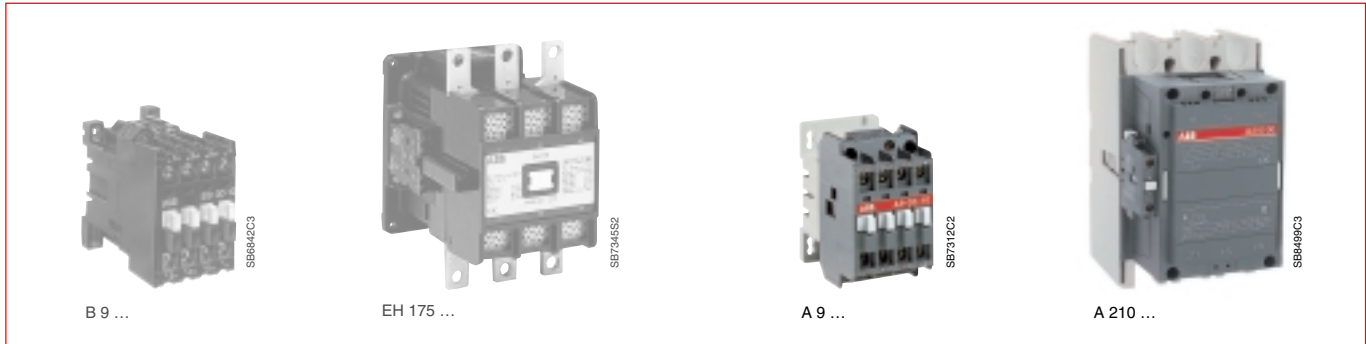

### B., EH.. Series, 3-pole Contactors

Motor rating <b>AC-3</b>	Contactor type	Rated operational current		Thermal O/L relay type
		<b>AC-3</b> 380 V 400 V A	<b>AC-1</b> $\theta \leq 40\text{ }^\circ\text{C}$ A	
4	B 9-30-10	9	22	T 25 DU ..
	B 9-30-01	9	22	T 25 DU ..
	B 9-30-22	9	22	T 25 DU ..
	B 9-30-32	9	22	T 25 DU ..
5.5	B 12-30-10	12	24	T 25 DU ..
	B 12-30-01	12	24	T 25 DU ..
	B 12-30-22	12	24	T 25 DU ..
	B 12-30-32	12	24	T 25 DU ..
7.5	B 16-30-10	16	28	T 25 DU ..
	B 16-30-01	16	28	T 25 DU ..
	B 16-30-22	16	28	T 25 DU ..
	B 16-30-32	16	28	T 25 DU ..
11	B 25-30-10	25	45	T 25 DU ..
	B 25-30-01	25	45	T 25 DU ..
	B 25-30-32	25	45	T 25 DU ..
15	B 30-30-00	30	55	T 25 DU ..
	B 30-30-22	30	55	T 25 DU ..
18.5	B 40-30-00	37	70	T 75 DU ..
	B 40-30-11	37	70	T 75 DU ..
	B 40-30-22	37	70	T 75 DU ..
22	B 50-30-00	50	100	T 75 DU ..
	B 50-30-11	50	100	T 75 DU ..
	B 50-30-22	50	100	T 75 DU ..
30	B 63-30-00	65	115	T 75 DU ..
	B 63-30-11	65	115	T 75 DU ..
	B 63-30-22	65	115	T 75 DU ..
37	B 75-30-00	75	125	T 75 DU ..
	B 75-30-11	75	125	T 75 DU ..
	B 75-30-22	75	125	T 75 DU ..
40	-	-	-	-
	EH 80-30-11	80	145	T 80 DU ..
45	-	-	-	-
	EH 90-30-11	96	160	T 100 DU ..
55	EH 100-30-11	120	200	T 135 DU ..
	EH 100-30-22	120	200	T 135 DU ..
75	EH 145-30-11	145	230	T 200 DU ..
	EH 145-30-22	145	230	T 200 DU ..
90	EH 175-30-11	185	260	T 200 DU ..
	EH 175-30-22	185	260	T 200 DU ..
110	EH 210-30-11	210	300	T 450 DU ..
	EH 210-30-22	210	300	T 450 DU ..

### A.. Series, 3-pole Contactors

Contactor type	Rated operational current		Thermal O/L relay type
	<b>AC-3</b> 380 V 400 V A	<b>AC-1</b> $\theta \leq 40\text{ }^\circ\text{C}$ A	
A 9-30-10	9	25	TA 25 DU ..
A 9-30-01	9	25	TA 25 DU ..
A 9-30-22	9	25	TA 25 DU ..
A 9-30-32	9	25	TA 25 DU ..
A 12-30-10	12	27	TA 25 DU ..
A 12-30-01	12	27	TA 25 DU ..
A 12-30-22	12	27	TA 25 DU ..
A 12-30-32	12	27	TA 25 DU ..
A 16-30-10	17	30	TA 25 DU ..
A 16-30-01	17	30	TA 25 DU ..
A 16-30-22	17	30	TA 25 DU ..
A 16-30-32	17	30	TA 25 DU ..
A 26-30-10	26	45	TA 25 DU ..
A 26-30-01	26	45	TA 25 DU ..
A 26-30-32	26	45	TA 25 DU ..
A 30-30-10	32	55	TA 25 DU ..
A 30-30-01	32	55	TA 25 DU ..
A 30-30-32	32	55	TA 25 DU ..
A 40-30-10	37	60	TA 42 DU ..
A 40-30-01	37	60	TA 42 DU ..
A 40-30-32	37	60	TA 42 DU ..
A 50-30-00	50	100	TA 75 DU ..
A 50-30-11	50	100	TA 75 DU ..
A 50-30-22	50	100	TA 75 DU ..
A 63-30-00	65	115	TA 75 DU ..
A 63-30-11	65	115	TA 75 DU ..
A 63-30-22	65	115	TA 75 DU ..
A 75-30-00	75	125	TA 75 DU ..
A 75-30-11	75	125	TA 75 DU ..
A 75-30-22	75	125	TA 75 DU ..
A 95-30-00	96	145	TA 110 DU ..
A 95-30-11	96	145	TA 110 DU ..
A 95-30-00	96	145	TA 110 DU ..
A 95-30-11	96	145	TA 110 DU ..
A 95-30-22	96	145	TA 110 DU ..
A 110-30-11	110	160	TA 110 DU ..
A 110-30-00	110	160	TA 110 DU ..
A 110-30-22	110	160	TA 110 DU ..
A 145-30-11	145	250	E 200 DU ..
A 145-30-22	145	250	E 200 DU ..
A 185-30-11	185	275	E 200 DU ..
A 185-30-22	185	275	E 200 DU ..
A 210-30-11	210	350	E 320 DU ..
A 210-30-22	210	350	E 320 DU ..

# Conversion Tables

## EH., B., EK.. Series to A., EK.. Series

### EH.. Series, 3-pole Contactors (cont.)

Motor rating <b>AC-3</b>	Contactor type	Rated operational current		Thermal O/L relay type
		<b>AC-3</b> 380 V <b>400 V</b> A	<b>AC-1</b> $\theta \leq 40\text{ }^{\circ}\text{C}$ A	
380 V / 400 V kW	EH 260-30-11	260	400	T 450 DU ..
	EH 260-30-22	260	400	T 450 DU ..
140				
160	EH 300-30-11	305	445	T 450 DU ..
	EH 300-30-22	305	445	T 450 DU ..
200	EH 370-30-11	400	550	T 450 DU ..
	EH 370-30-22	400	550	T 450 DU ..
250	-	-	-	-
280	EH 550-30-11	550	800	T 900 DU ..
	EH 550-30-22	550	800	T 900 DU ..
315	-	-	-	-
370	EH 700-30-11	700	1000	T 900 DU ..
	EH 700-30-22	700	1000	T 900 DU ..
400	EH 800-30-11	750	1000	T 900 DU ..
	EH 800-30-22	750	1000	T 900 DU ..

### A.. Series, 3-pole Contactors (cont.)

Contactor type	Rated operational current		Thermal O/L relay type
	<b>AC-3</b> 380 V <b>400 V</b> A	<b>AC-1</b> $\theta \leq 40\text{ }^{\circ}\text{C}$ A	
A 260-30-11	260	400	E 320 DU ..
A 260-30-22	260	400	E 320 DU ..
A 300-30-11	305	500	E 320 DU ..
A 300-30-22	305	500	E 320 DU ..
AF 400-30-11	400	600	E 500 DU ..
AF 400-30-22	400	600	E 500 DU ..
AF 460-30-11	460	700	E 500 DU ..
AF 460-30-22	460	700	E 500 DU ..
-	-	-	-
AF 580-30-11	580	800	E 800 DU ..
AF 580-30-22	580	800	E 800 DU ..
-	-	-	-
AF 750-30-11	750	1050	E 800 DU ..
AF 750-30-22	750	1050	E 800 DU ..

### B., EK.. Series, 4-pole Contactors - 4 NO

Contactor type	Rated operational current <b>AC-1</b> $\theta \leq 40\text{ }^{\circ}\text{C}$ A
B 9-40-00	22
B 12-40-00	24
B 16-40-00	28
B 25-40-00	45
-	-
B 40-40-00	80
B 50-40-00	125
EK 100-40-11	200
-	-
EK 145-40-11	250
-	-
EK 160-40-11	300
-	-
EK 200-40-11	350
-	-
EK 370-40-11	550
-	-
EK 550-40-11	800
-	-
-	-
-	-

### A., EK.. Series, 4-pole Contactors - 4 NO

Contactor type	Rated operational current <b>AC-1</b> $\theta \leq 40\text{ }^{\circ}\text{C}$ A
A 9-40-00	25
A 9-40-00	25
A 16-40-00	30
A 26-40-00	45
A 45-40-00	70
A 50-40-00	100
A 75-40-00	125
EK 110-40-11	200
EK 110-40-22	200
EK 150-40-11	250
EK 150-40-22	250
EK 175-40-11	300
EK 175-40-22	300
EK 210-40-11	350
EK 210-40-22	350
EK 370-40-11	550
EK 370-40-22	550
EK 550-40-11	800
EK 550-40-22	800
EK 1000-40-11	1000
EK 1000-40-11	1000

### B.. Series, 4-pole Contactors - 2 NO + 2 NC

Contactor type	Rated operational current <b>AC-1</b> $\theta \leq 40\text{ }^{\circ}\text{C}$ A
B 9-22-00	22
B 12-22-00	24
B 16-22-00	28
B 25-22-00	45
-	-
-	-

### A.. Series, 4-pole Contactors - 2 NO + 2 NC

Contactor type	Rated operational current <b>AC-1</b> $\theta \leq 40\text{ }^{\circ}\text{C}$ A
A 9-22-00	25
A 9-22-00	25
A 16-22-00	30
A 26-22-00	45
A 45-22-00	70
A 75-22-00	125







## Contents

### Choose your Components

Switching of Motors AC-3 .....	42
Switching of Resistive Circuits AC-1 .....	43

### Ordering Details

B 6, B 7 Mini Contactors and Accessories .....	44
VB 6A, VB 7A Compact Reversing Contactors and Accessories .....	44
Thermal O/L Relays .....	45
K 6 Mini Contactor Relays and Accessories .....	45
Technical Data .....	45

# Choose your Components

## Switching of Motors AC-3

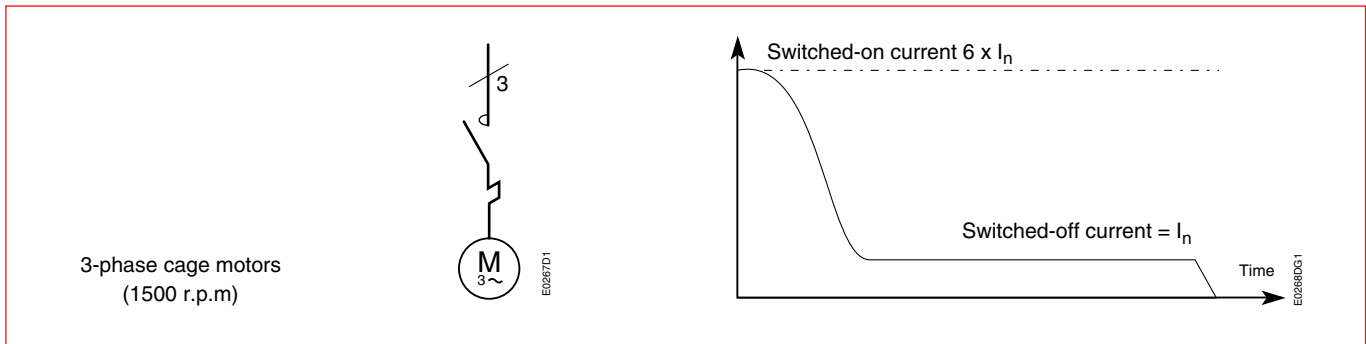

**AC-3 utilization category** When **making**, the motor current is about **6 x I<sub>n</sub>**.  
**Breaking** while the motor is running at I<sub>n</sub> motor **F.L.C.**  
 Occasional breaking while motor is starting at **6 x I<sub>n</sub>**.

**O/L relay class** The table below gives thermal O/L relays,  
 for standard starting times 2 ... 10 s, tripping class **10A**.

### Motor

Motor rating			
Rated current			
3-phase cage motor, 1500 r.p.m (1)			
380 V / 400 V		415 V	
kW	A	kW	A
0.06	0.22	0.06	0.20
0.09	0.33	0.09	0.30
0.12	0.42	0.12	0.40
0.18	0.64	0.18	0.60
0.25	0.88	0.25	0.85
0.37	1.22	0.37	1.15
0.55	1.5	0.55	1.40
0.75	2	0.75	2
1.1	2.6	1.1	2.5
1.5	3.5	1.5	3.5
2.2	5	2.2	5
2.5	5.7	2.5	5.5
3	6.6	3	6.5
-	-	3.7	7.5
3.7	8.2	-	-
4	8.5	4	8.4
-	-	5	10
5	10.5	-	-
5.5	11.5	5.5	11

### Mini Contactor

Rated operational current AC-3		Type	Auxiliary contacts fitted	
$\theta \leq 55^\circ\text{C}$		State coil voltage: <input type="checkbox"/>	<input type="checkbox"/>	<input type="checkbox"/>
380 V	415 V			
400 V	A	A		
9	8.5	B 6-30-10 <input type="checkbox"/>	1	-
9	8.5	B 6-30-10 <input type="checkbox"/>	1	-
9	8.5	B 6-30-10 <input type="checkbox"/>	1	-
9	8.5	B 6-30-10 <input type="checkbox"/>	1	-
9	8.5	B 6-30-10 <input type="checkbox"/>	1	-
9	8.5	B 6-30-10 <input type="checkbox"/>	1	-
9	8.5	B 6-30-10 <input type="checkbox"/>	1	-
9	8.5	B 6-30-10 <input type="checkbox"/>	1	-
9	8.5	B 6-30-10 <input type="checkbox"/>	1	-
9	8.5	B 6-30-10 <input type="checkbox"/>	1	-
9	8.5	B 6-30-10 <input type="checkbox"/>	1	-
9	8.5	B 6-30-10 <input type="checkbox"/>	1	-
12	11.5	B 7-30-10 <input type="checkbox"/>	1	-
12	11.5	B 7-30-10 <input type="checkbox"/>	1	-
12	11.5	B 7-30-10 <input type="checkbox"/>	1	-

### Thermal O/L Relay

Setting range	Type
A	
0.16 ... 0.24	T 7 DU 0.24
0.24 ... 0.40	T 7 DU 0.4
0.4 ... 0.6	T 7 DU 0.6
0.6 ... 1.0	T 7 DU 1.0
0.6 ... 1.0	T 7 DU 1.0
1.0 ... 1.6	T 7 DU 1.6
1.0 ... 1.6	T 7 DU 1.6
1.6 ... 2.4	T 7 DU 2.4
2.4 ... 4.0	T 7 DU 4.0
2.4 ... 4.0	T 7 DU 4.0
4.0 ... 6.0	T 7 DU 6.0
4.0 ... 6.0	T 7 DU 6.0
6.0 ... 9.0	T 7 DU 9.0
6.0 ... 9.0	T 7 DU 9.0
6.0 ... 9.0	T 7 DU 9.0
9.0 ... 12.0	T 7 DU 12.0
9.0 ... 12.0	T 7 DU 12.0
9.0 ... 12.0	T 7 DU 12.0

(1) The currents shown in the above table are those given for standard three phase squirrel cage motors, 1500 r.p.m. 50 Hz. Values quoted are for guidance only, they can vary depending on the number of poles and design. For motor duty with plugging, inching (utilization category AC-4), please consult us. Motor current values at other operational voltages, see page 31.

### Coil voltage B 6, B 7

50 Hz (V)
24
42
48
110 ... 127
220 ... 240
380 ... 415

# Choose your Components

## Switching of Resistive Circuits AC-1

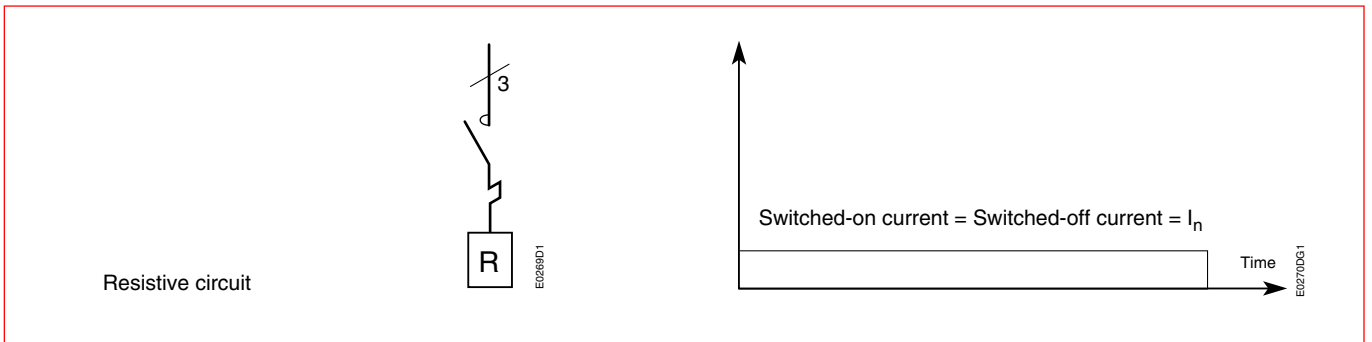

**AC-1 utilization category** When **making**, the switched-on current is equal to the **load rated current  $I_n$** , and  **$\cos \varphi \geq 0.95$** .

**Component selection** Component selection must take into account the air ambient temperature inside the cabinets. The required cable cross-sections are indicated below.

### 3-pole Mini Contactors

Rated operational current <b>AC-1</b> 380 V - 400 V - 415 V		With cable cross-sections	Type	Auxiliary contacts fitted	Max. back-up fuse gG Co.ordination :	
$\theta \leq 40^\circ\text{C}$ A	$\theta \leq 55^\circ\text{C}$ A	mm <sup>2</sup>	State coil voltage: [ ] [ ]		Type 1 A	Type 2 A
16	16	2.5	B 6-30-10 [ ] [ ]	1 -	20	20
20	16	2.5	B 7-30-10 [ ] [ ]	1 -	25	20

### 4-pole Mini Contactors

Rated operational current <b>AC-1</b> 380 V - 400 V - 415 V		With cable cross-sections	Type	Auxiliary contacts fitted	Max. back-up fuse gG Co.ordination :	
$\theta \leq 40^\circ\text{C}$ A	$\theta \leq 55^\circ\text{C}$ A	mm <sup>2</sup>	State coil voltage: [ ] [ ]		Type 1 A	Type 2 A
16	16	2.5	B 6-40-00 [ ] [ ]	- -	20	20
20	16	2.5	B 7-40-00 [ ] [ ]	- -	25	20

#### Coil voltage B 6, B 7

50 Hz (V)
24
42
48
110 ... 127
220 ... 240
380 ... 415

# Mini Contactors Compact Reversing Contactors

For Screw Connection - a.c. coil



B6 30-10



CAF 6-11M



VB 6A-30-10



BSM 6-30

### Coil voltages and codes

Voltage (V)	Voltage code
50 Hz :	<input type="checkbox"/> . . <input type="checkbox"/>
24	<input type="checkbox"/> . . <input type="checkbox"/> 1
42	<input type="checkbox"/> . . <input type="checkbox"/> 2
48	<input type="checkbox"/> . . <input type="checkbox"/> 3
110 ... 127	<input type="checkbox"/> . . <input type="checkbox"/> 4
220 ... 240	<input type="checkbox"/> . . <input type="checkbox"/> 0
380 ... 415	<input type="checkbox"/> . . <input type="checkbox"/> 5

## B 6 and B 7 Mini Contactors

Rated operational current	Auxiliary contacts fitted	Type	Order code	Pack <sup>ing</sup>	Weight each	
<b>AC-3</b> 380 V 400 V A	<b>AC-1</b> $\theta \leq 40^\circ\text{C}$ A	State coil voltage: <input type="checkbox"/> <input type="checkbox"/>	coil voltage code see table below: <input type="checkbox"/> . . <input type="checkbox"/>	pieces	kg	
9	8.5 16	1 - - 1 - -	B 6-30-10 <input type="checkbox"/> <input type="checkbox"/> B 6-30-01 <input type="checkbox"/> <input type="checkbox"/> B 6-40-00 <input type="checkbox"/> <input type="checkbox"/>	GJL 121 1001 R <input type="checkbox"/> 10 <input type="checkbox"/> GJL 121 1001 R <input type="checkbox"/> 01 <input type="checkbox"/> GJL 121 1201 R <input type="checkbox"/> 00 <input type="checkbox"/>	10 10 10	0.180 0.180 0.180
12	11.5 20	1 - - 1 - -	B 7-30-10 <input type="checkbox"/> <input type="checkbox"/> B 7-30-01 <input type="checkbox"/> <input type="checkbox"/> B 7-40-00 <input type="checkbox"/> <input type="checkbox"/>	GJL 131 1001 R <input type="checkbox"/> 10 <input type="checkbox"/> GJL 131 1001 R <input type="checkbox"/> 01 <input type="checkbox"/> GJL 131 1201 R <input type="checkbox"/> 00 <input type="checkbox"/>	10 10 10	0.180 0.180 0.180

### Auxiliary contact blocks for B 6 and B 7 Types CA 6 and CAF 6 must not be fitted together

Positioning	Mounting on :	Contacts	Type	Order code	Pack <sup>ing</sup>	Weight
Side	B 6-30-10 and B 7-30-10	1 1	CA 6-11M	GJL 120 1317 R0003	10	0.030
	B 6-30-01 and B 7-30-01	1 1	CA 6-11N	GJL 120 1317 R0004	10	0.030
	B 6-40-00 and B 7-40-00	1 1	CA 6-11E	GJL 120 1317 R0002	10	0.030
Front face	B 6-30-10 and B 7-30-10	1 1 2 - - 2	CAF 6-11M CAF 6-20M CAF 6-02M	GJL 120 1330 R0003 GJL 120 1330 R0007 GJL 120 1330 R0011	10 10 10	0.035 0.035 0.035
	B 6-30-01 and B 7-30-01	1 1 2 - - 2	CAF 6-11N CAF 6-20N CAF 6-02N	GJL 120 1330 R0004 GJL 120 1330 R0008 GJL 120 1330 R0012	10 10 10	0.035 0.035 0.035
	B 6-40-00 and B 7-40-00	1 1 2 - - 2	CAF 6-11E CAF 6-20E CAF 6-02E	GJL 120 1330 R0002 GJL 120 1330 R0006 GJL 120 1330 R0010	10 10 10	0.035 0.035 0.035

### Other accessories for B 6 and B 7

Feature	Mounting on :	Type	Order code	Pack <sup>ing</sup>	Weight
With soldering pins	B 6, B 7	LB 6	GJL 120 1902 R0001	10	0.014
	CA 6-11	LB 6-CA	GJL 120 1903 R0001	10	0.006
Identification marker	Front face	BA 5-50	1SBN 11 0000 R1000	50	0.017
Protective cover (IP 20 category)		LT 6 B	GJL 120 1906 R0001	10	0.001

## VB 6A and VB 7A Compact Reversing Contactors

Rated operational current	Auxiliary contacts fitted	Type	Order code	Pack <sup>ing</sup>	Weight each	
<b>AC-3</b> 380 V 400 V A	<b>AC-1</b> $\theta \leq 40^\circ\text{C}$ A	State coil voltage: <input type="checkbox"/> <input type="checkbox"/>	coil voltage code see table below: <input type="checkbox"/> . . <input type="checkbox"/>	pieces	kg	
9	8.5 16	1 - - 1	VB 6A-30-10 <input type="checkbox"/> <input type="checkbox"/> VB 6A-30-01 <input type="checkbox"/> <input type="checkbox"/>	GJL 121 1911 R <input type="checkbox"/> 10 <input type="checkbox"/> GJL 121 1911 R <input type="checkbox"/> 01 <input type="checkbox"/>	5 5	0.340 0.340
12	11.5 20	1 - - 1	VB 7A-30-10 <input type="checkbox"/> <input type="checkbox"/> VB 7A-30-01 <input type="checkbox"/> <input type="checkbox"/>	GJL 131 1911 R <input type="checkbox"/> 10 <input type="checkbox"/> GJL 131 1911 R <input type="checkbox"/> 01 <input type="checkbox"/>	5 5	0.340 0.340

### Accessories for VB 6A and VB 7A

Feature	Type	Order code	Pack <sup>ing</sup>	Weight
Connection link (cable cross-section 1.8 mm <sup>2</sup> )	BSM 6-30	GJL 120 1908 R0001	10	0.010
Function marker	BA 5-50	1SBN 11 0000 R1000	50	0.017

>> Thermal O/L relays ..... page 45

>> Dimensions ..... page 51

# Thermal O/L Relays - Mini Contactor Relays

## Technical Data for Mini Contactors



### Thermal O/L Relays, Tripping Class 10A for mini contactors B6, B7, VB 6A and VB 7A

Setting range A	Type	Order code	Pack <sup>ing</sup> piece	Weight kg
0.10 ... 0.16	T 7 DU 0.16	1SAZ 111 301 R0001	1	0.070
0.16 ... 0.24	T 7 DU 0.24	1SAZ 111 301 R0002	1	0.070
0.24 ... 0.40	T 7 DU 0.4	1SAZ 111 301 R0003	1	0.070
0.4 ... 0.6	T 7 DU 0.6	1SAZ 111 301 R0004	1	0.070
0.6 ... 1.0	T 7 DU 1.0	1SAZ 111 301 R0005	1	0.070
1.0 ... 1.6	T 7 DU 1.6	1SAZ 111 301 R0006	1	0.070
1.6 ... 2.4	T 7 DU 2.4	1SAZ 111 301 R0007	1	0.070
2.4 ... 4.0	T 7 DU 4.0	1SAZ 111 301 R0008	1	0.070
4.0 ... 6.0	T 7 DU 6.0	1SAZ 111 301 R0009	1	0.070
6.0 ... 9.0	T 7 DU 9.0	1SAZ 111 301 R0010	1	0.070
9.0 ... 12.0	T 7 DU 12.0	1SAZ 111 301 R0011	1	0.070

### Mini Contactor Relays K 6

Auxiliary contacts fitted	Type	Order code	Pack <sup>ing</sup> each	Weight kg
	State coil voltage: <input type="checkbox"/> <input type="checkbox"/>	coil voltage code see table below: <input type="checkbox"/> . . <input type="checkbox"/>	pieces	kg
4 -	K 6-40 E <input type="checkbox"/>	GJH 121 1001 R <input type="checkbox"/> 40 <input type="checkbox"/>	10	0.180
3 1	K 6-31 Z <input type="checkbox"/>	GJH 121 1001 R <input type="checkbox"/> 31 <input type="checkbox"/>	10	0.180
2 2	K 6-22 Z <input type="checkbox"/>	GJH 121 1201 R <input type="checkbox"/> 22 <input type="checkbox"/>	10	0.180

### Auxiliary contact block for K 6 Types CA 6 and CAF 6 must not be fitted together.

Positioning	Contacts	Type	Order code	Pack <sup>ing</sup> pieces	Weight kg
Side		CA 6-11K	GJL 120 1317 R0001	10	0.030
Front face		CAF 6-11K	GJL 120 1330 R0001	10	0.035
		CAF 6-20K	GJL 120 1330 R0005	10	0.035
		CAF 6-02K	GJL 120 1330 R0009	10	0.035

### Other accessories for mini contactor relays K 6

Feature	Type	Order code	Pack <sup>ing</sup> pieces	Weight kg
Function marker	BA 5-50	1SBN 11 0000 R1000	50	0.017
Protective cover (IP 20 category)	LT 6-B	GJL 120 1906 R0001	10	0.001

## Technical Data for Mini Contactors

Types	B 6, VB 6A	B 7, VB 7A	Types	All types	
Rated operational current I <sub>e</sub> / AC-3	220-240 V A	9	Cable cross-section	rigid mm <sup>2</sup> 2 x (1 ... 2.5)	
	380-440 V A	9/8		flexible mm <sup>2</sup> 2 x (0.75 ... 2.5)	
	500 V A	5.5		Degree of protection of the terminals	VBG 4
				Coil consumption pull-in / holding VA	3.5
Max. back-up fuse gG			Auxiliary contacts - I <sub>e</sub> / AC-15	220-240 V A 4	
Co.ordination type 1 A	20	380-440 V A 3			
Co.ordination type 2 A	20	500 V A 2			
			Max. back-up fuse gG	A 10	

>> Dimensions ..... page 51



ABB  
120 150  
ICB 1000 40  
1700 A  
500 V  
50 Hz  
SPO 8

⚡ WARNING

CE

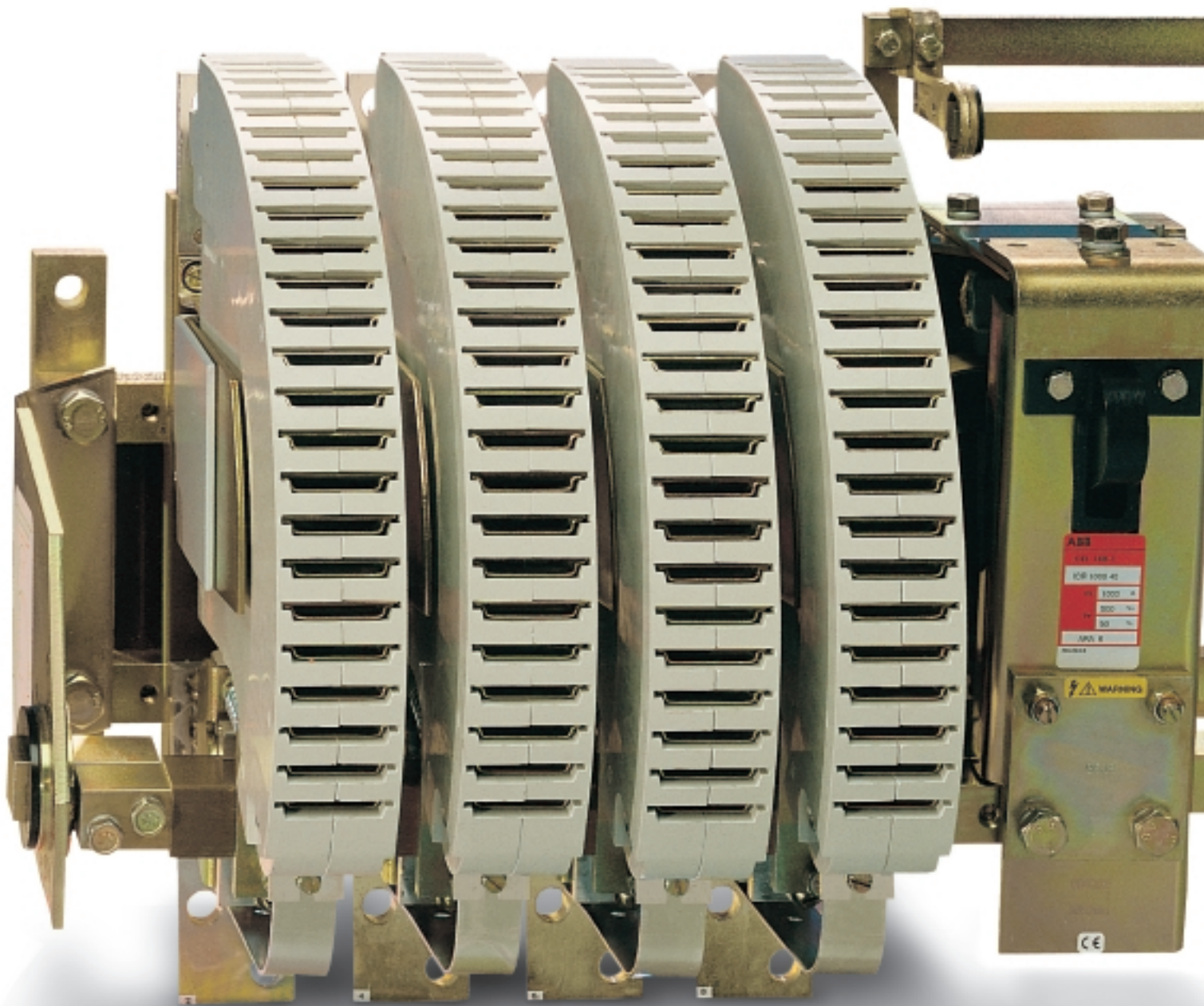
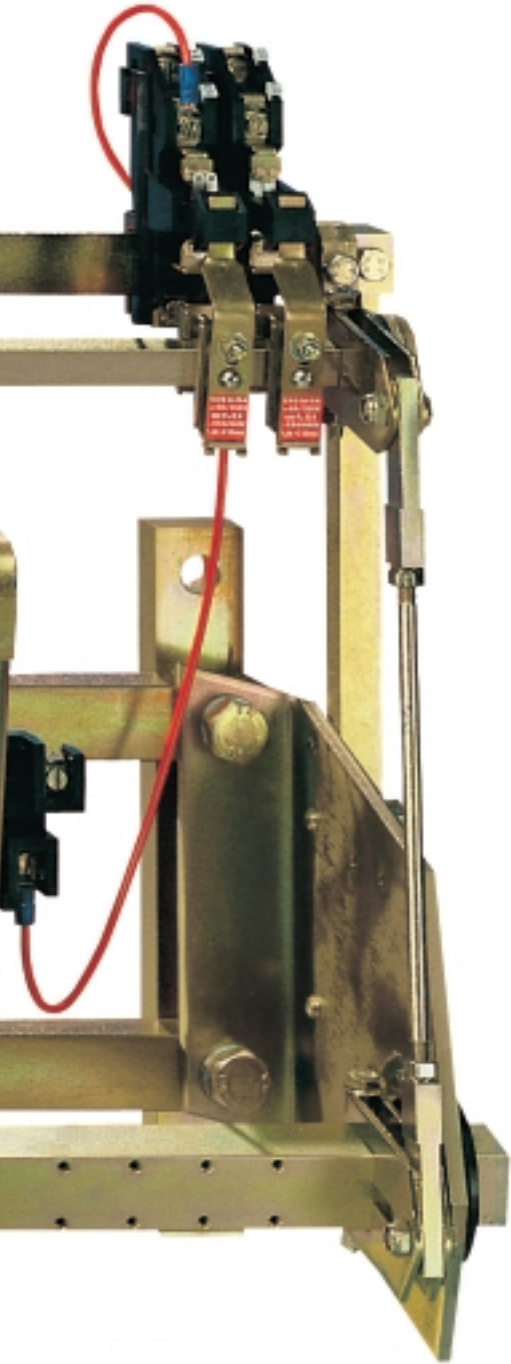

## Contents

### Ordering Details

3-pole Contactors .....	48
4-pole Contactors .....	48
Accessories .....	49
Thermal-magnetic O/L Relays .....	49

# Bar Mounted Contactors - a.c. Coil

## Ordering Details

### 3-pole Contactors

Motor rating <b>AC-3</b>	Rated operational current <b>AC-3 AC-1</b>		Auxiliary contacts fitted	Type	Order code	Weight kg
400 V kW	400 V A	$\theta \leq 40$ °C A		State coil voltage: <input type="text"/>	coil voltage code see table below: <input type="text"/> <input type="text"/>	Pack <sup>ing</sup> 1 piece
40	77	85	1 1	IOR 85 30 <input type="text"/>	FPL 721 1316 R <input type="text"/> 00 <input type="text"/>	4.000
80	150	170	1 1	IOR 170 30 <input type="text"/>	FPL 751 1315 R <input type="text"/> 00 <input type="text"/>	6.200
132	240	260	1 1	IOR 260 30 <input type="text"/>	FPL 781 1315 R <input type="text"/> 00 <input type="text"/>	10.300
200	370	420	1 1	IOR 420 30 <input type="text"/>	FPL 811 1315 R <input type="text"/> 00 <input type="text"/>	13.500
300	550	550	1 1	IOR 550 30 <input type="text"/>	FPL 841 1315 R <input type="text"/> 00 <input type="text"/>	25.000
440	800	900	1 1	IOR 800 30 <input type="text"/>	FPL 861 1315 R <input type="text"/> 00 <input type="text"/>	48.000

### 4-pole Contactors

Rated operational current <b>AC-1</b>	Auxiliary contacts fitted	Type	Order code	Weight kg
$\theta \leq 40$ °C A		State coil voltage: <input type="text"/>	coil voltage code see table below: <input type="text"/> <input type="text"/>	Pack <sup>ing</sup> 1 piece
85	1 1	IOR 85 40 <input type="text"/>	FPL 721 1416 R <input type="text"/> 00 <input type="text"/>	4.700
170	1 1	IOR 170 40 <input type="text"/>	FPL 751 1415 R <input type="text"/> 00 <input type="text"/>	7.600
260	1 1	IOR 260 40 <input type="text"/>	FPL 781 1415 R <input type="text"/> 00 <input type="text"/>	12.700
420	1 1	IOR 420 40 <input type="text"/>	FPL 811 1415 R <input type="text"/> 00 <input type="text"/>	16.600
550	1 1	IOR 550 40 <input type="text"/>	FPL 841 1415 R <input type="text"/> 00 <input type="text"/>	30.800
900	1 1	IOR 800 40 <input type="text"/>	FPL 861 1415 R <input type="text"/> 00 <input type="text"/>	58.000
1000	1 1	IOR 1000 40 <input type="text"/>	FPL 871 1415 R <input type="text"/> 00 <input type="text"/>	58.000
1250	1 1	IORR 1250 40 <input type="text"/>	FPL 881 5415 R <input type="text"/> 00 <input type="text"/>	85.000
1500	1 1	IORR 1500 40 <input type="text"/>	FPL 891 5415 R <input type="text"/> 00 <input type="text"/>	85.000
2000	1 1	IORR 2000 40 <input type="text"/>	FPL 901 5415 R <input type="text"/> 00 <input type="text"/>	105.000

### Coil voltages and codes

Voltage (V) 50 Hz: <input type="text"/>	Voltage code: <input type="text"/> <input type="text"/>
24	<input type="text"/> 0 <input type="text"/> 1
48	<input type="text"/> 1 <input type="text"/> 7
110	<input type="text"/> 0 <input type="text"/> 4
220 ... <b>230</b>	<input type="text"/> 0 <input type="text"/> 6
230 ... 240	<input type="text"/> 2 <input type="text"/> 9
380 ... <b>400</b>	<input type="text"/> 0 <input type="text"/> 7
400 ... 415	<input type="text"/> 3 <input type="text"/> 4

Other voltages : please consult us.

>> Accessories ..... page 49 >> Dimensions ..... Please consult us

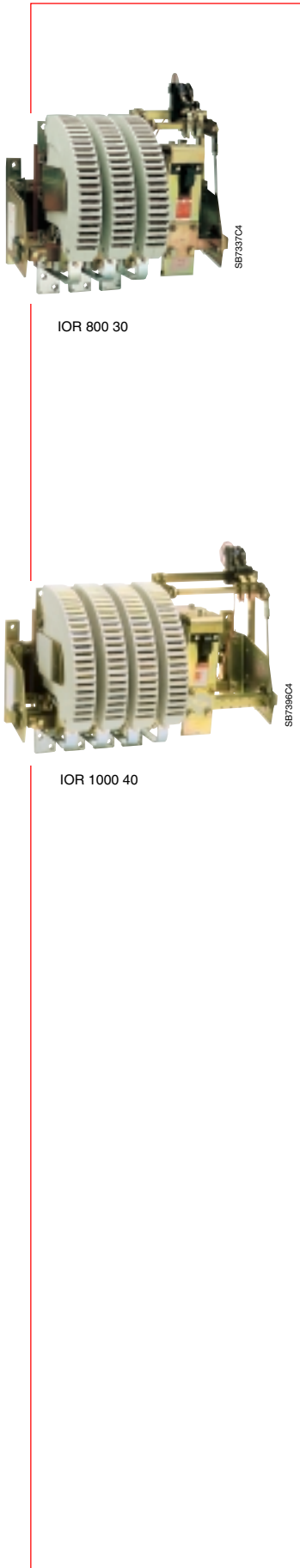



# Accessories for Bar Mounted Contactors

## Ordering Details

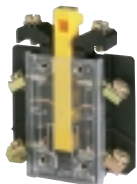

CA 12-1

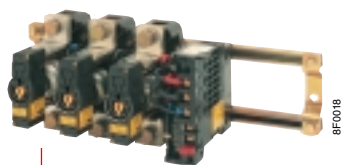

RKR..

### Extra Auxiliary Contacts

Mounting on :	Contacts	Type	Order code	Pack <sup>ing</sup> piece	Weight kg
IOR 85 ... IOR 550 (on mounting bracket - 3 blocks max.)	1 1	CA 12-1	FPTN 410 004 R0001	1	0.042
IOR 800 ... IOR 1000 (on auxiliary frame - 3 blocks max.)	1 - - 1	CA 15 F 85 CA 15 O 85	FPL 710 1301 R0001 FPL 710 1302 R0001	1 1	0.138 0.138
IORR 1250 ... IORR 2000 (on auxiliary frame - 2 blocks max.)	1 - - 1	CA 15 F 85 CA 15 O 85	FPL 710 1301 R0001 FPL 710 1302 R0001	1 1	0.138 0.138

### Mounting Bracket for CA 12 blocks

Mounting on :	Type	Order code	Pack <sup>ing</sup> piece	Weight kg
IOR 85 ... IOR 260 (On magnet circuit)	FPTN 410 056 R1	FPTN 410 056 R0001	1	0.105
IOR 420 ... IOR 550 (On magnet circuit)	FPTN 410 056 R2	FPTN 410 056 R0002	1	0.121

### Mounting Feet for "wall" mounting of the contactors

Mounting on :	Type	Order code	Pack <sup>ing</sup> set	Weight kg
IOR 85, IOR 170	4 NMW 1009	FPL 710 8201 P0001	1	0.062
IOR 260	4 NMW 1039	FPL 760 8201 P0001	1	0.062
IOR 420	4 NMW 1040	FPL 800 8201 P0001	1	0.316
IOR 550	4 NMW 1041	FPL 830 8201 P0001	1	0.304

Note : contactors IOR 800 ... IORR 2000 require no mounting feet.

### Thermal-magnetic O/L Relays

Mounting on :	Setting range Thermal A	Magnetic A	Type	Order code	Pack <sup>ing</sup> piece	Weight kg
IOR 85	12.5 ... 25	125 ... 250	RKR 3 AHDM 225	FPU 793 1323 R2000	1	2.700
	20 ... 40	200 ... 400	RKR 3 AHDM 240	FPU 803 1323 R2000	1	2.700
	31.5 ... 63	315 ... 630	RKR 3 AHDM 263	FPU 813 1323 R2000	1	2.700
	50 ... 100	500 ... 1000	RKR 3 AHDM 310	FPU 823 1323 R2000	1	2.700
IOR 170	80 ... 160	800 ... 1600	RKR 3 AKDM 316	FPU 833 1324 R2000	1	2.700
IOR 260	125 ... 250	1250 ... 2500	RKR 3 ALDM 325	FPU 843 1325 R2000	1	2.800
IOR 420	200 ... 400	2000 ... 4000	RKR 3 AMDM 340	FPU 853 1326 R2000	1	3.600
IOR 550	315 ... 630	3150 ... 6300	RKR 3 ANDM 363	FPU 863 1327 R2000	1	4.200
IOR 800	500 ... 1000	5000 ... 10000	RKR 3 ANDM 410	FPU 873 1327 R2000	1	5.700

>> Dimensions ..... Please consult us

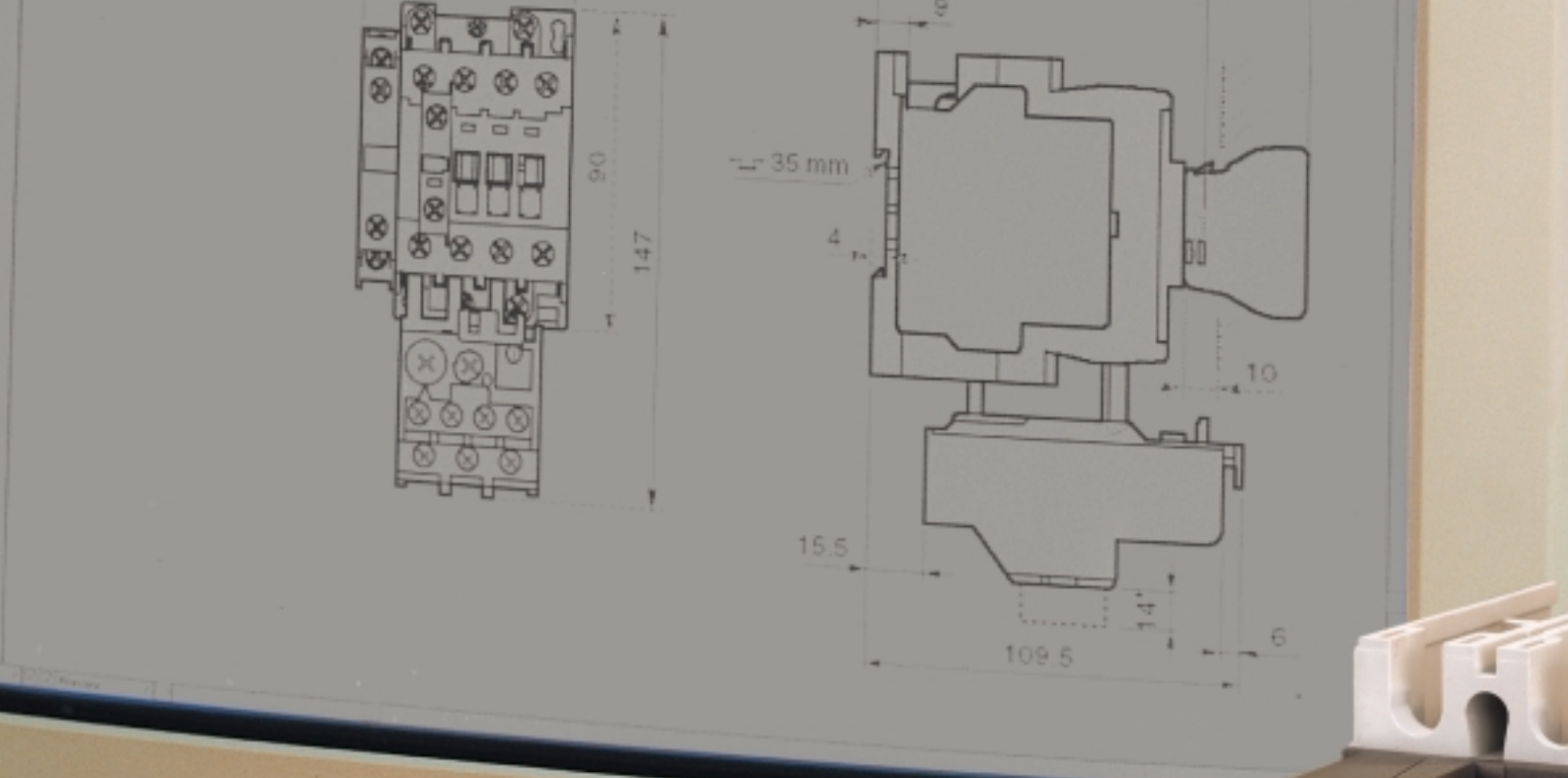

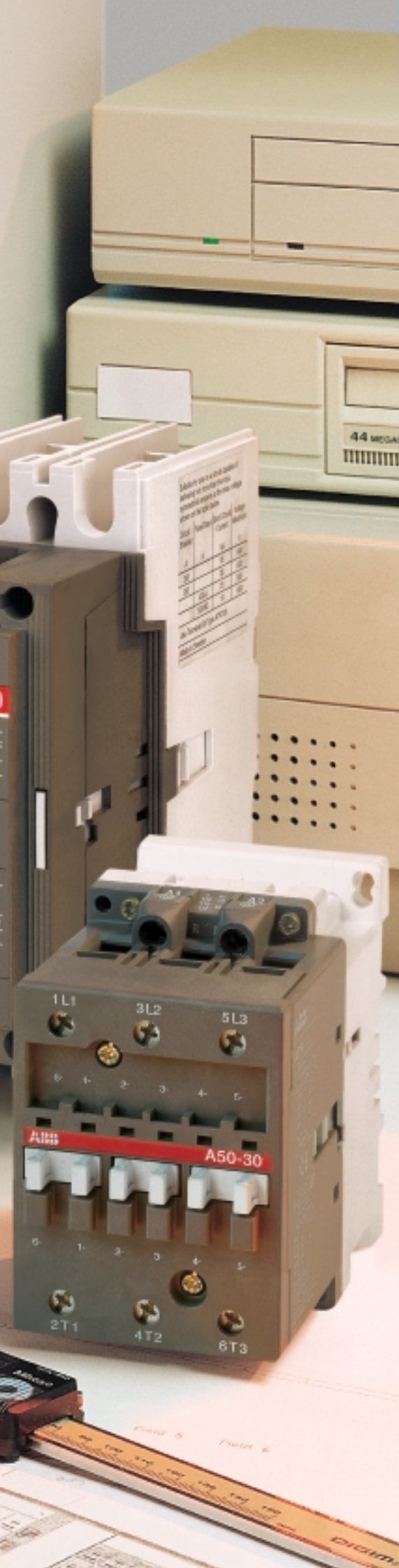

# Dimensions and Fixing Wiring Diagrams

## Contents

### Dimensions and fixing

A., AF.. 3-pole Contactors .....	52 to 58
A.. 4-pole Contactors .....	59
EK.. 4-pole Contactors .....	60
N.. Contactor Relays .....	61
D.A 9 ... D.A 16 D.O.L. Starters in Enclosure .....	61
YKA..-30 Star-Delta Starters .....	62, 63
VOA..-30M Reversing Contactors .....	64
VOA..-40Z Changeover Contactors .....	64
Mini Contactors .....	65

### Wiring diagrams

D.O.L. Starters in Enclosure .....	66
Star-Delta Starters .....	67
Reversing Contactors .....	68, 69
Changeover Contactors .....	69

# A9 ... A30 3-pole Contactors

## Dimensions (in mm)

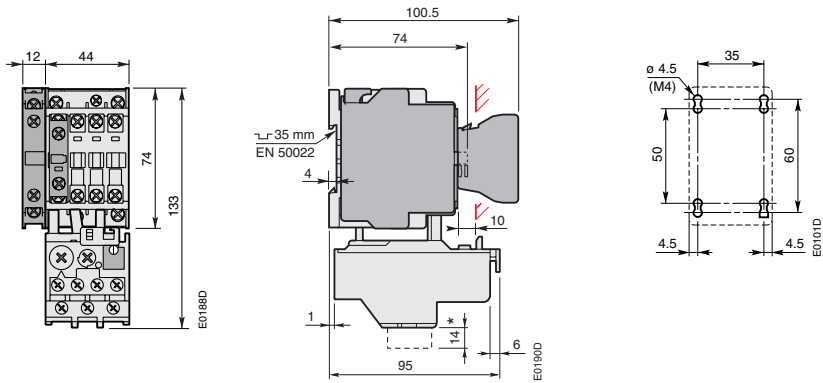

**A 9, A 12, A 16 + CA 5 + CAL 5 + TA 25 DU**

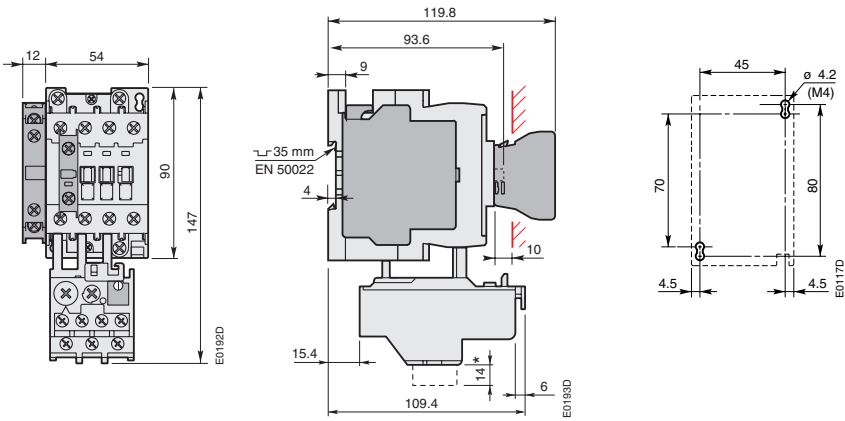

**A 26 + CA 5 + CAL 5 + TA 25 DU**

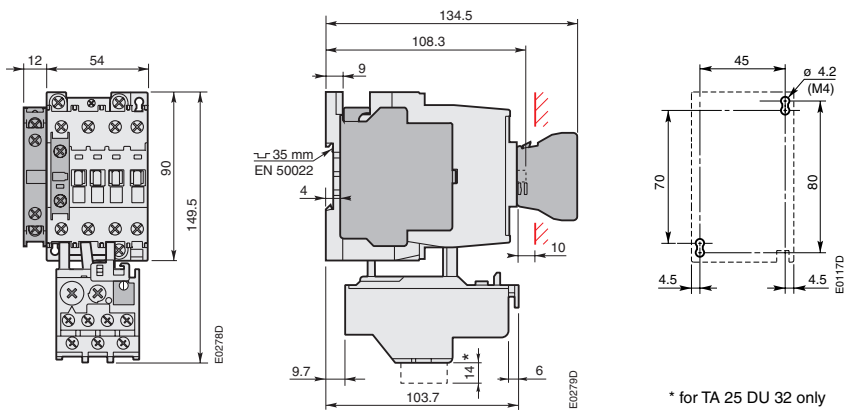

\* for TA 25 DU 32 only

**A 30 + CA 5 + CAL 5 + TA 25 DU**

Detailed dimension drawings available in DXF and PDF formats.

# A 40 ... A 75 3-pole Contactors

## Dimensions (in mm)

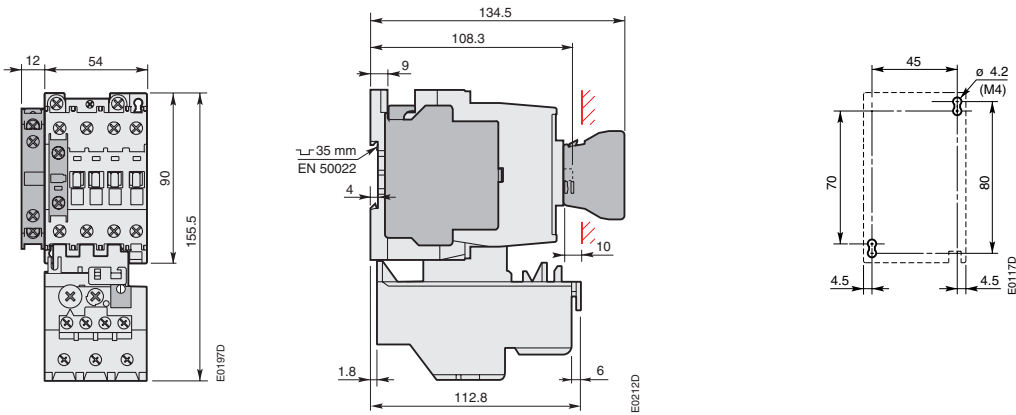

### A 40 + CA 5 + CAL 5 + TA 42 DU

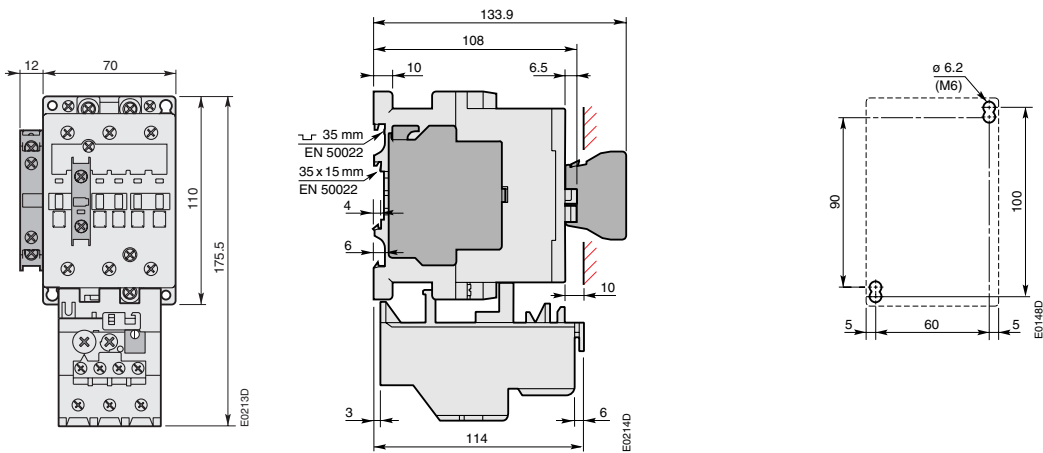

### A 50, A 63, A 75 + CA 5 + CAL 5 + TA 75 DU

Detailed dimension drawings available in DXF and PDF formats.

# A 95 and A 110 3-pole Contactors

## Dimensions (in mm)

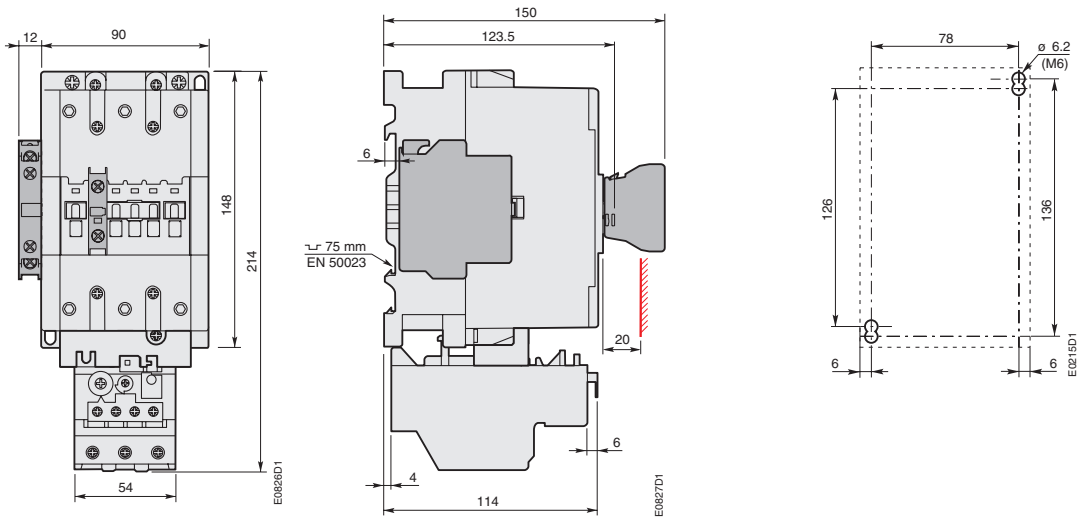

## A 95, A 110 + CA 5 + CAL 5 + TA 80 DU

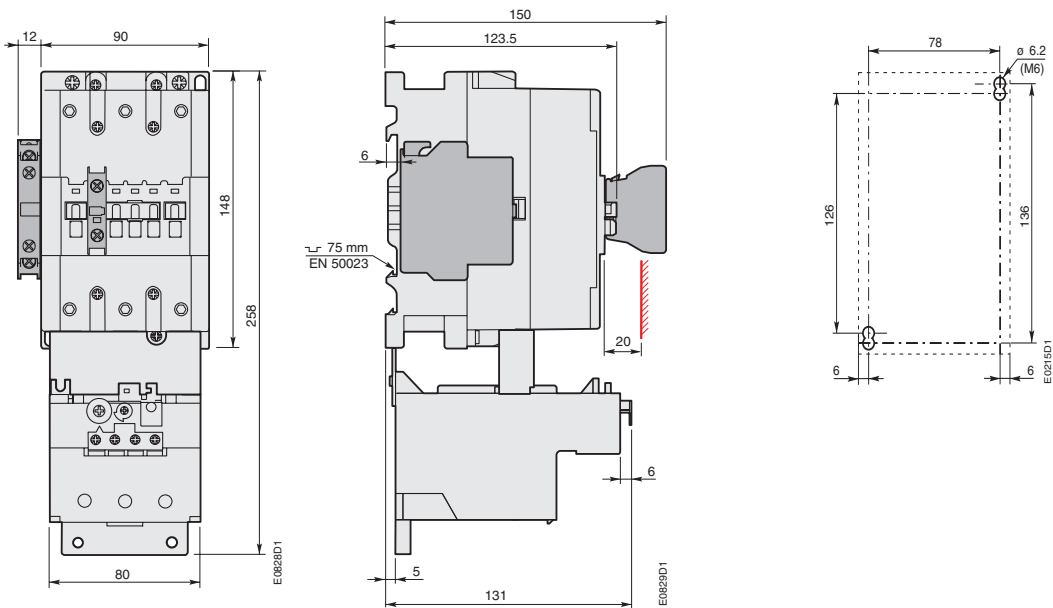

## A 95, A 110 + CA 5 + CAL 5 + TA 110 DU

Detailed dimension drawings available in DXF and PDF formats.

# A 145 and A 185 3-pole Contactors

## Dimensions (in mm)

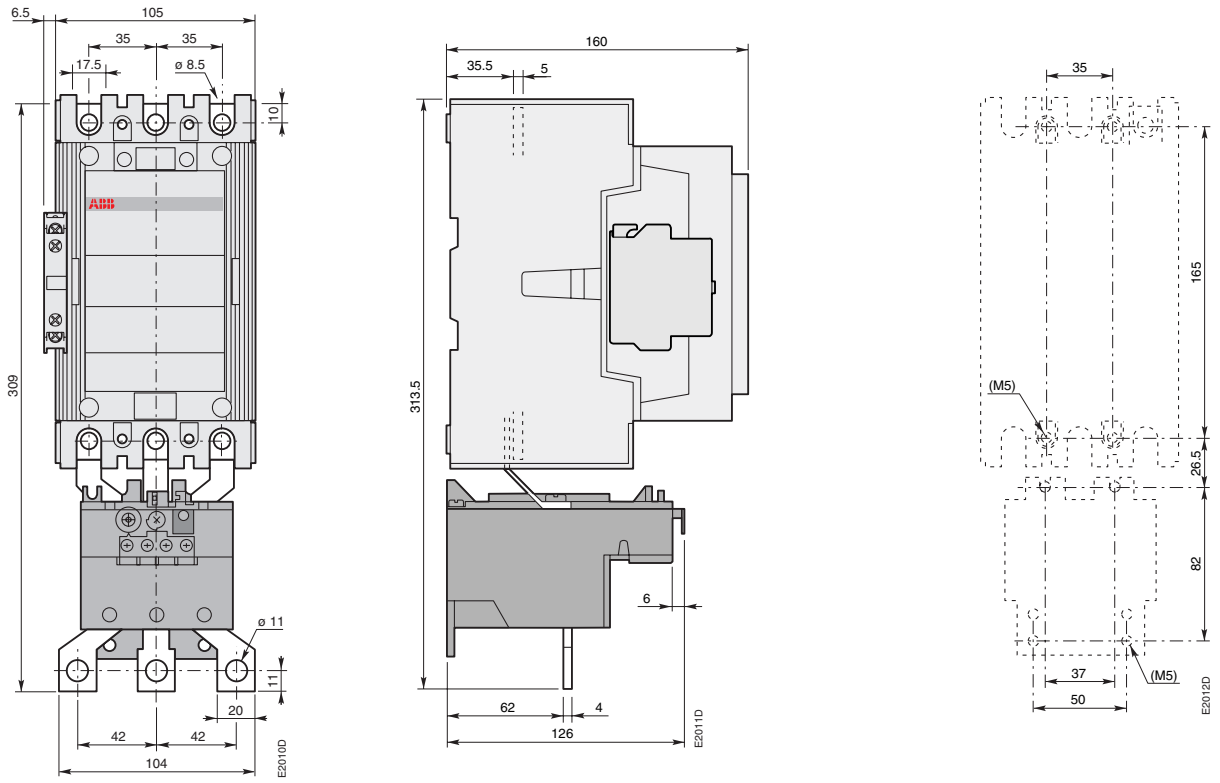

**A 145, A 185 c/w CAL 5 + TA 200 DU**

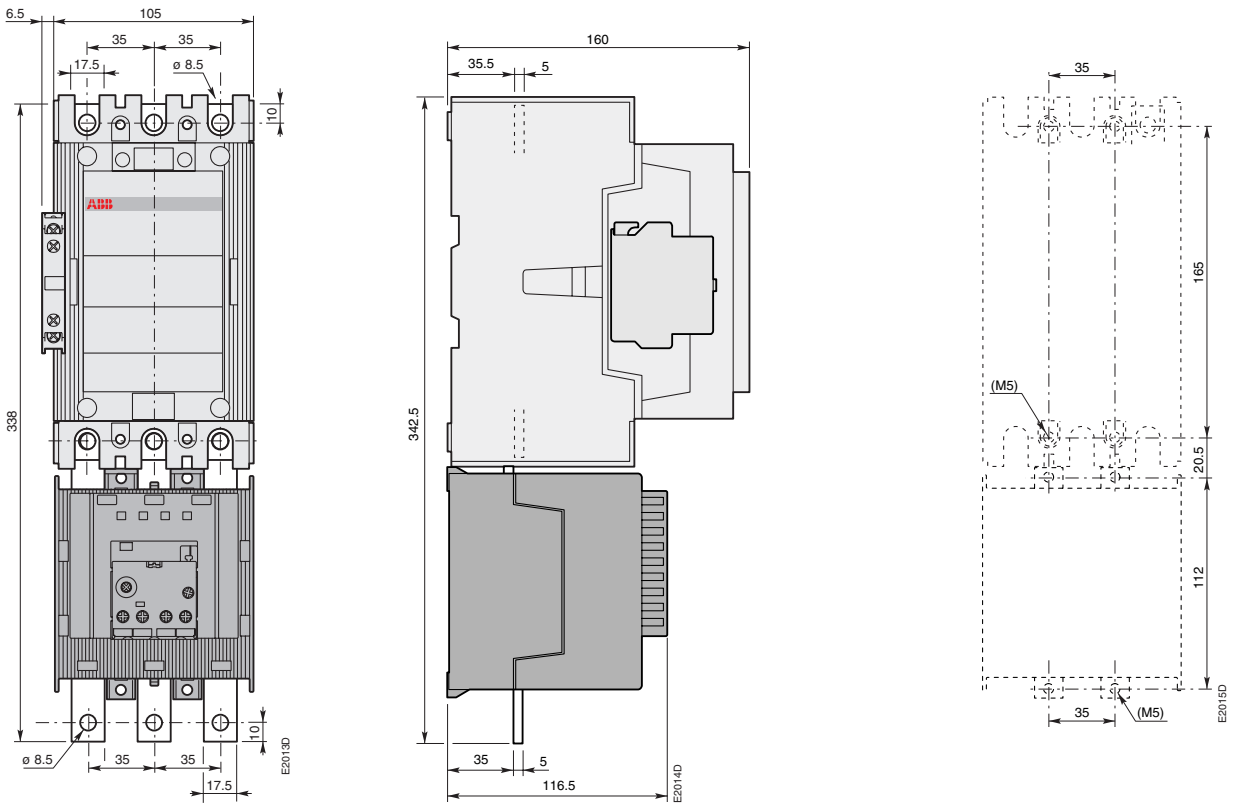

**A 145, A 185 c/w CAL 5 + E 200 DU**

Detailed dimension drawings available in DXF and PDF formats.

# A 210 ... A 300 3-pole Contactors

## Dimensions (in mm)

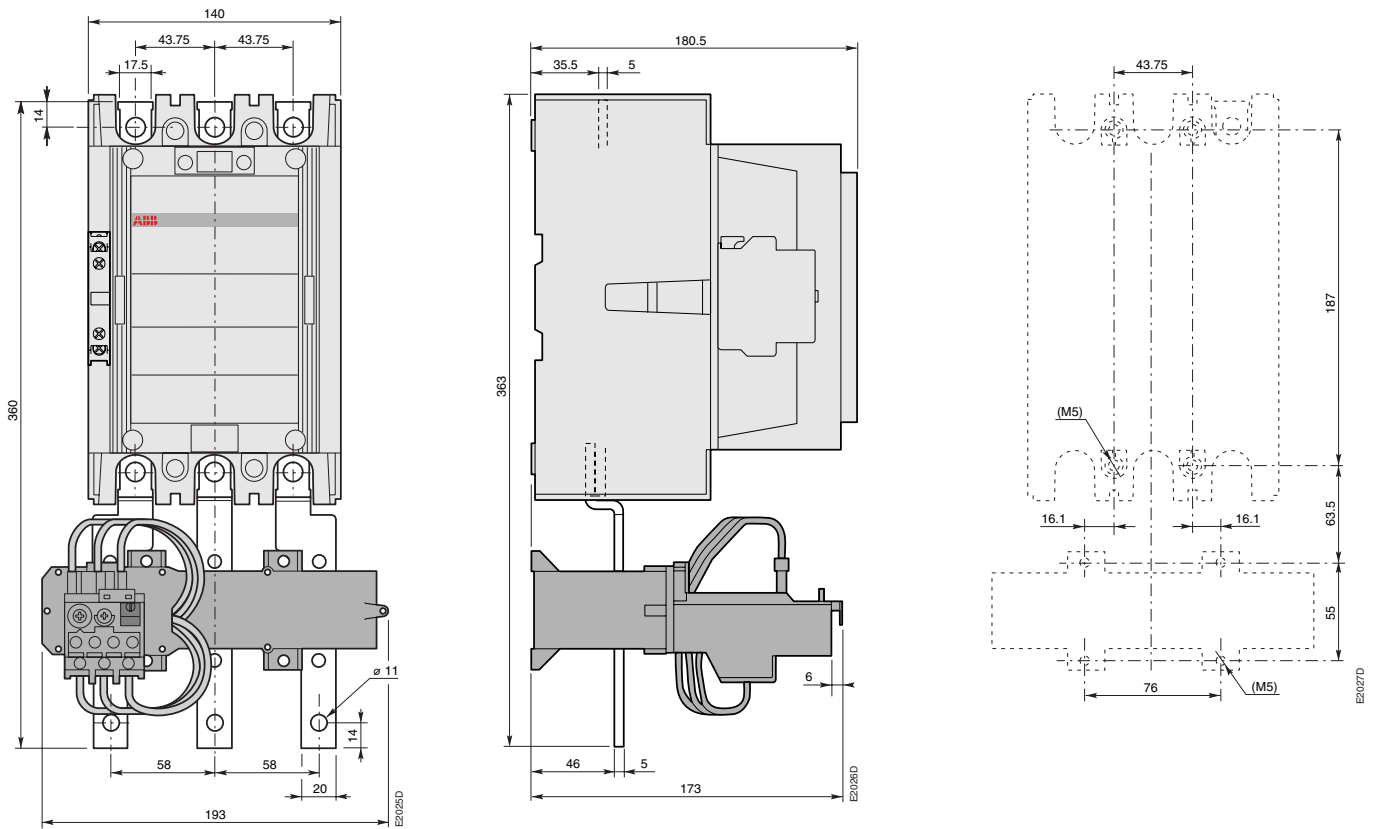

**A 210 ... A 300 c/w CAL 5 + TA 450 DU**

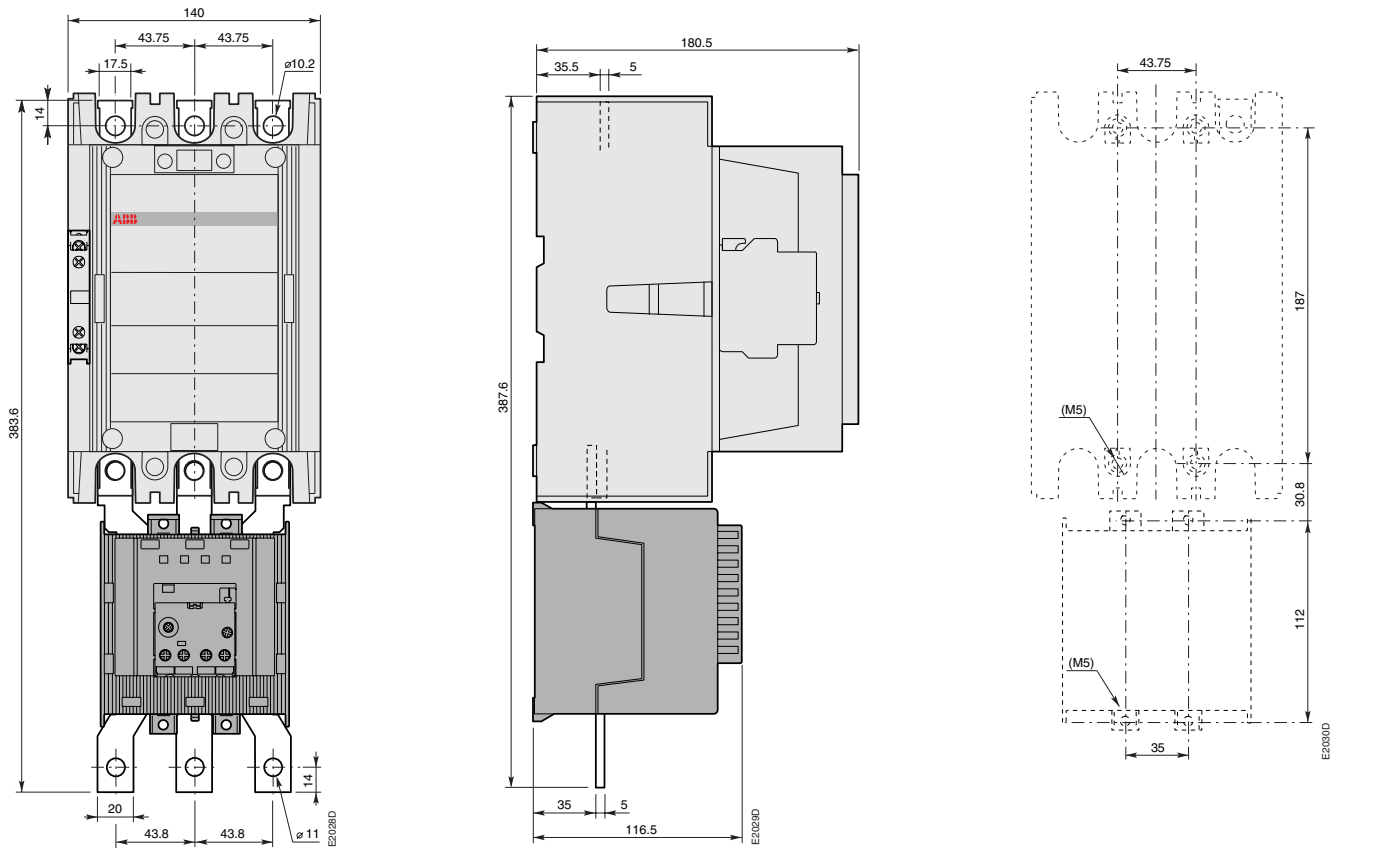

**A 210 ... A 300 c/w CAL 5 + E 320 DU**

Detailed dimension drawings available in DXF and PDF formats.



# AF 400 and AF 460 3-pole Contactors

## Dimensions (in mm)

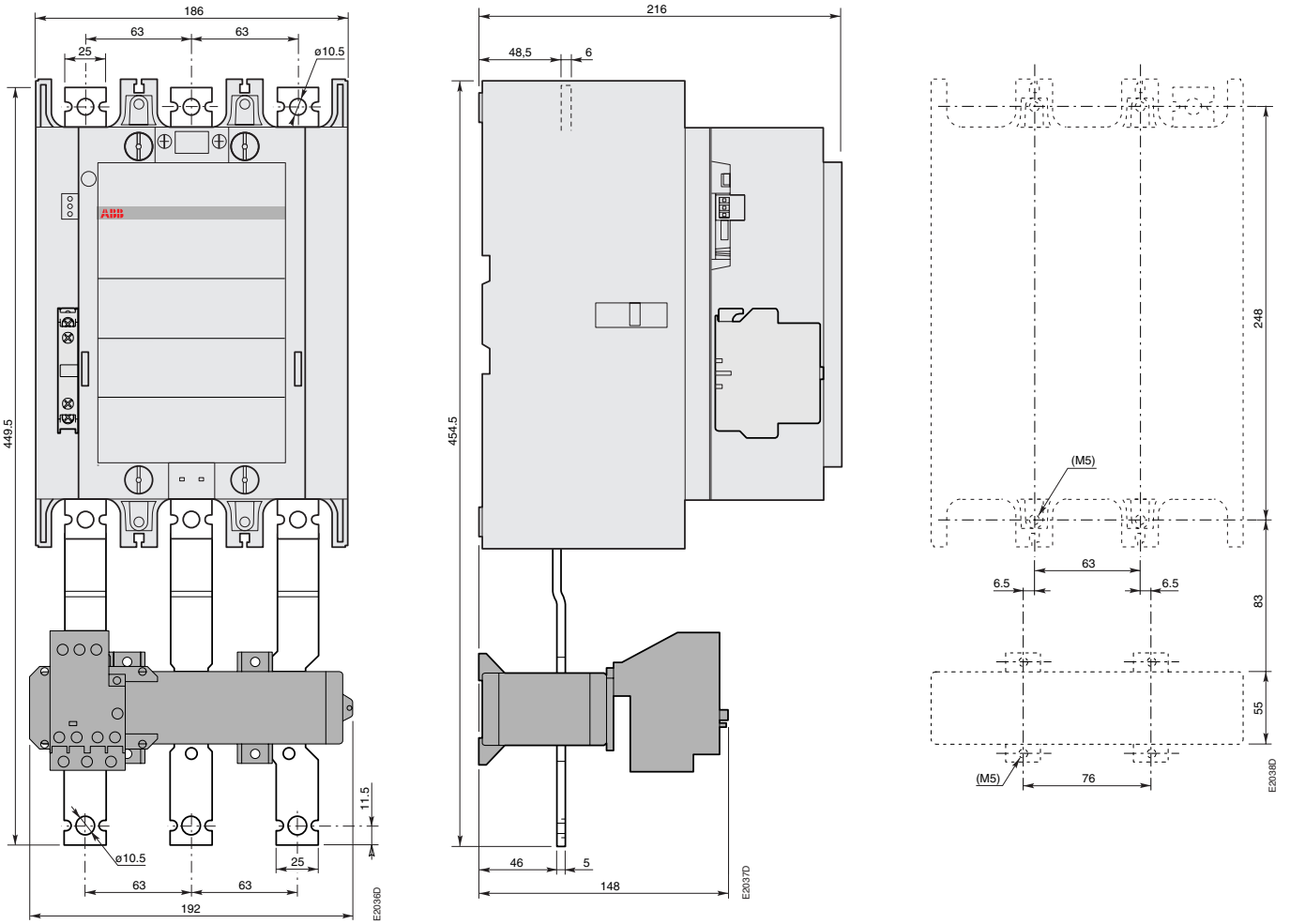

AF 400, AF 460 c/w CAL 5 + E 500 DU

Detailed dimension drawings available in DXF and PDF formats.

# AF 580 and AF 750 3-pole Contactors

## Dimensions (in mm)

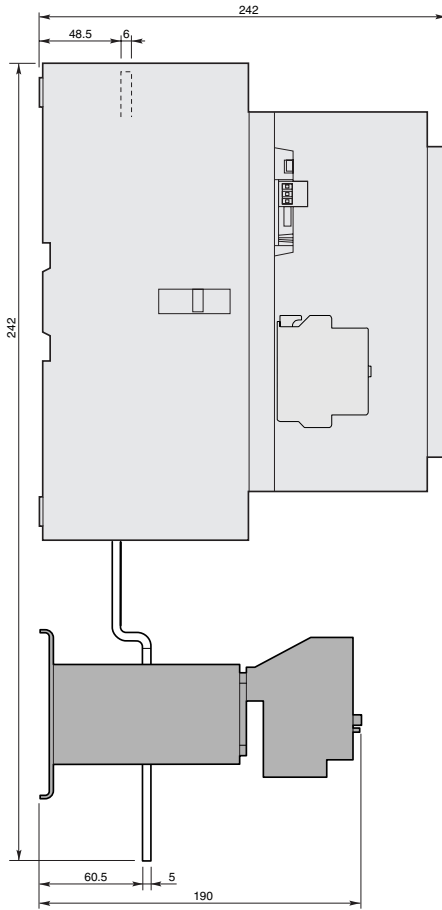
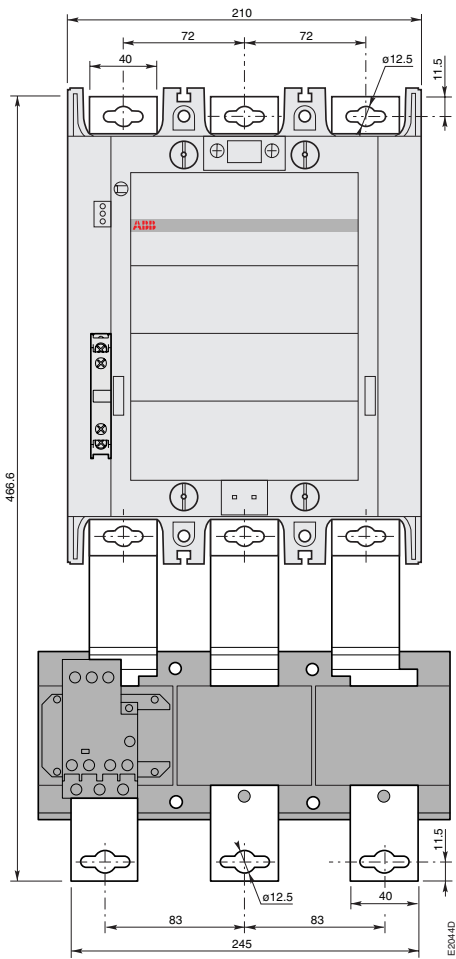

**AF 580, AF 750 c/w CAL 5 + E 800 DU**

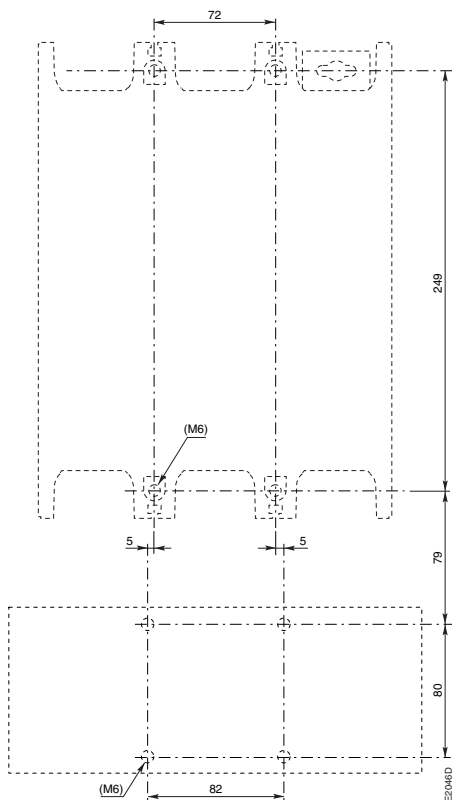

Detailed dimension drawings available in DXF and PDF formats.

# A9 ... A75 4-pole Contactors

## Dimensions (in mm)

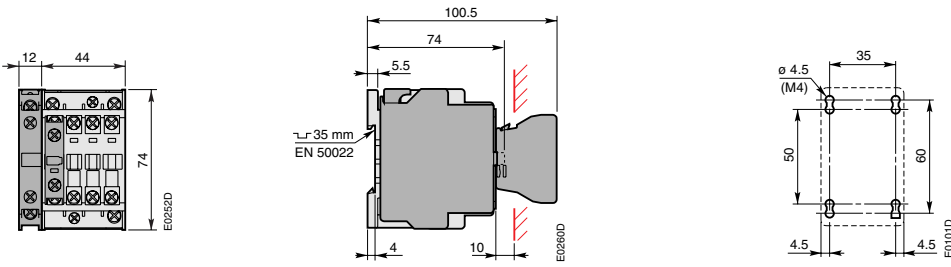

**A 9, A 12, A 16 + CA 5 + CAL 5**

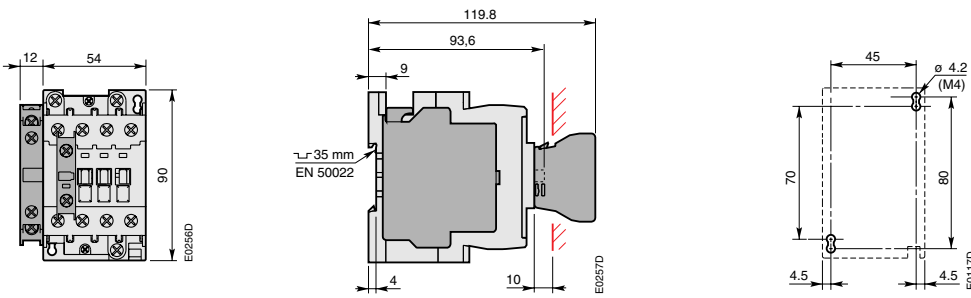

**A 26 + CA 5 + CAL 5**

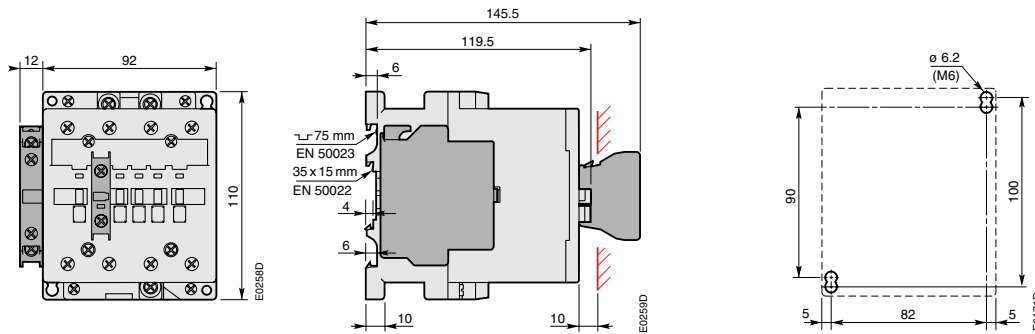

**A 45, A 50, A 75 + CA 5 + CAL 5**

Detailed dimension drawings available in DXF and PDF formats.

# EK 110 ... EK 1000 4-pole Contactors

## Dimensions (in mm)

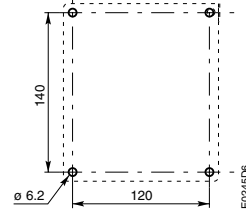
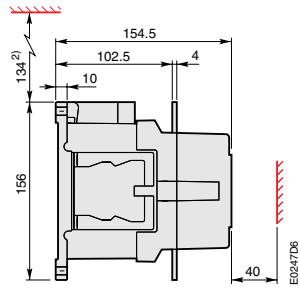
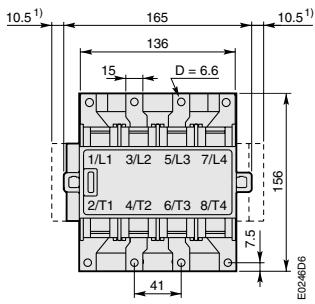

### EK 110 c/w CAL 16-11A

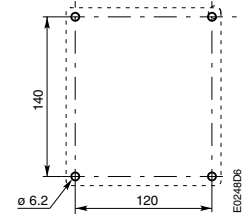
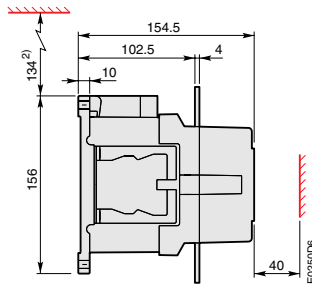
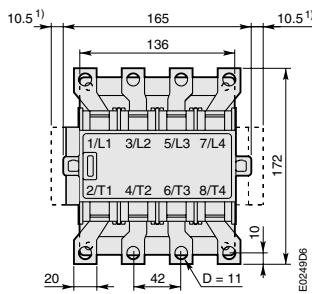

### EK 150 c/w CAL 16-11A

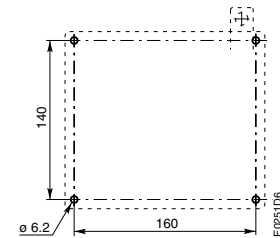
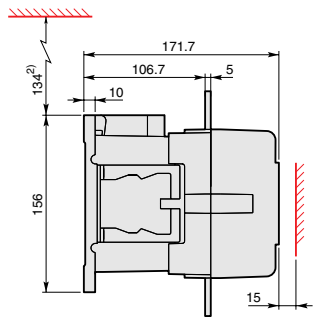
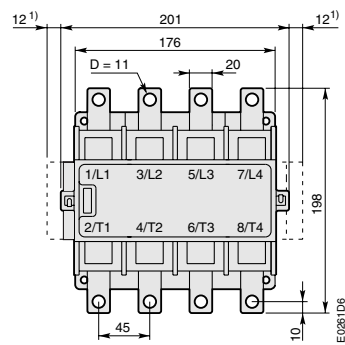

### EK 175, EK 210 c/w CAL 16-11A

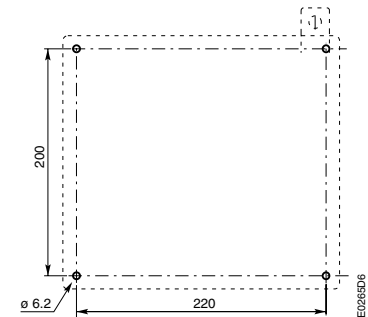
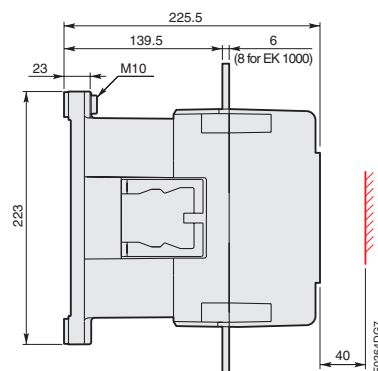
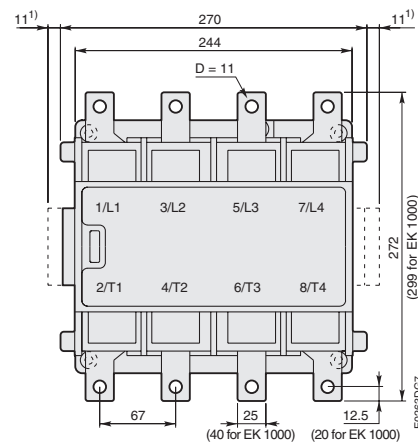

### EK 370, EK 550, EK 1000 c/w CAL 16-11A

- 1) Dimensions for extra auxiliary contact block.
- 2) Minimum distance to remove coil.

Detailed dimension drawings available in DXF and PDF formats.

# N.. Contactor Relays D.A., D.O.L. Starters

## Dimensions (in mm)

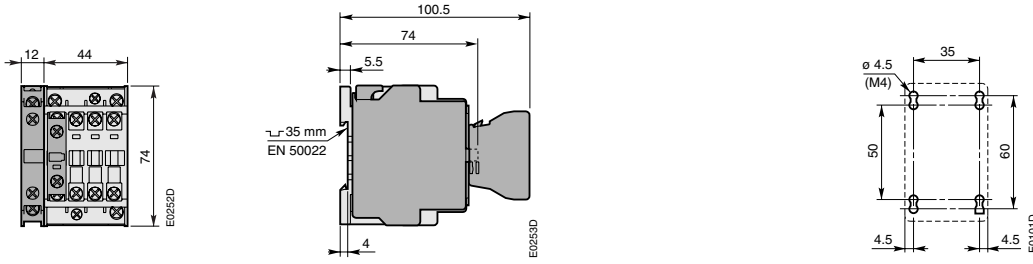

## N.. + CA 5 + CAL 5

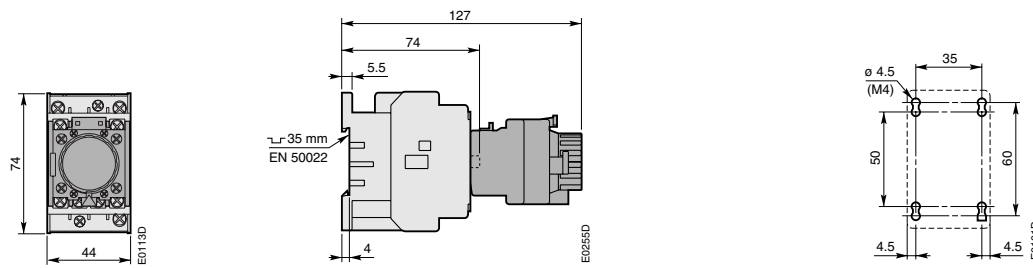

## N.. + TP.. A

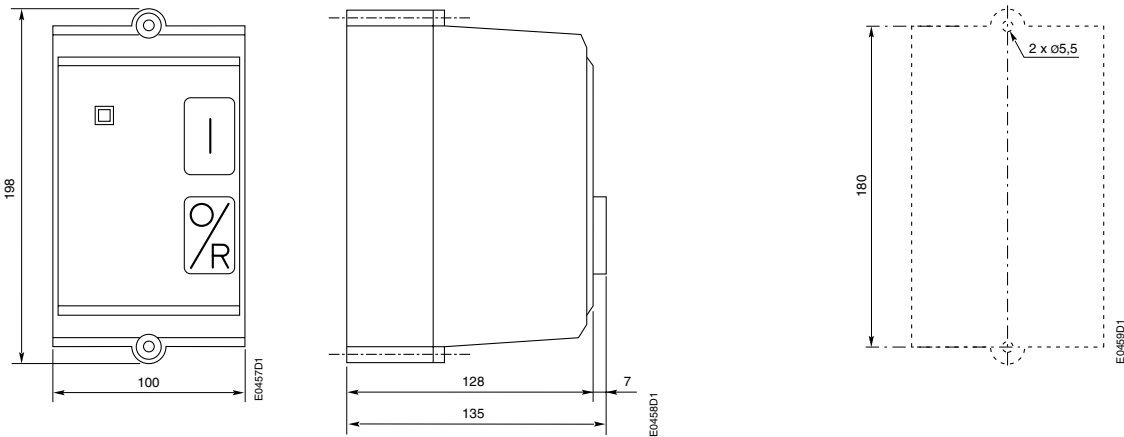

## D.A 9, D.A 12, D.A 16

Detailed dimension drawings available in DXF and PDF formats.

# YKA..-30 Star-Delta Starters

## Dimensions (in mm)

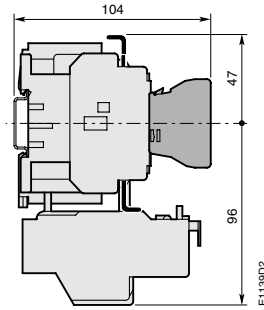
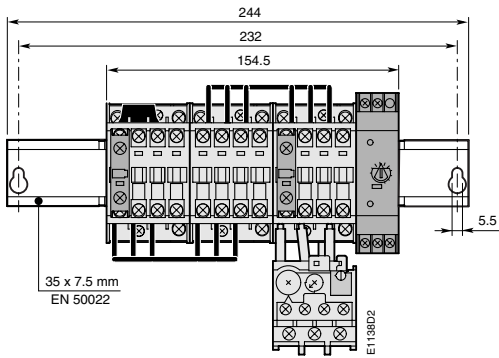

**YKA 9-30 ... YKA 16-30 + TA 25 DU**

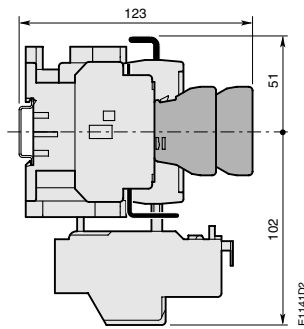
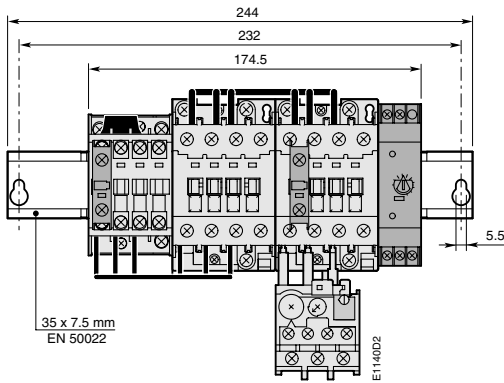

**YKA 26-30 + TA 25 DU**

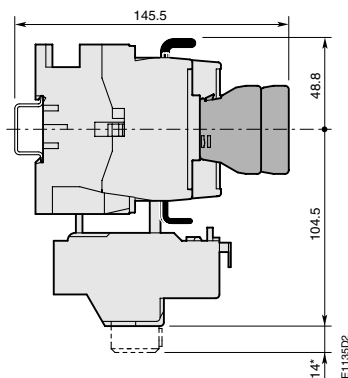
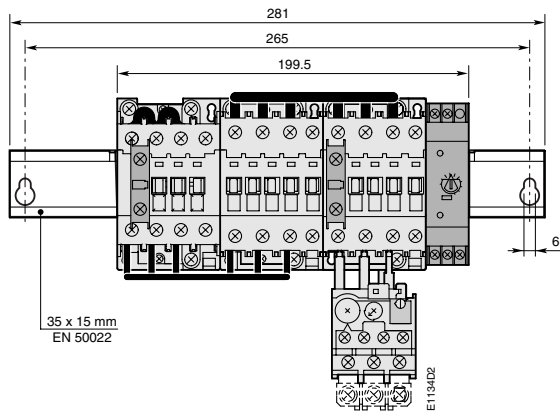

**YKA 30-30 + TA 25 DU**

\* for TA25 DU 32 only

# YKA..-30 Star-Delta Starters

## Dimensions (in mm)

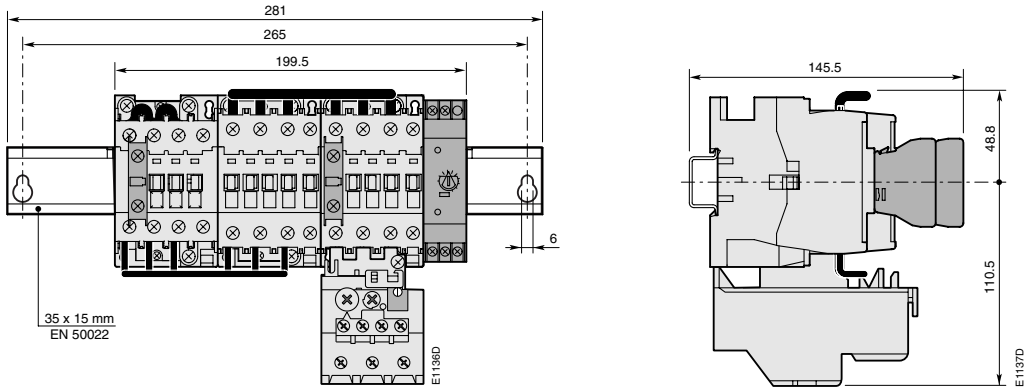

**YKA 40-30 + TA 42 DU**

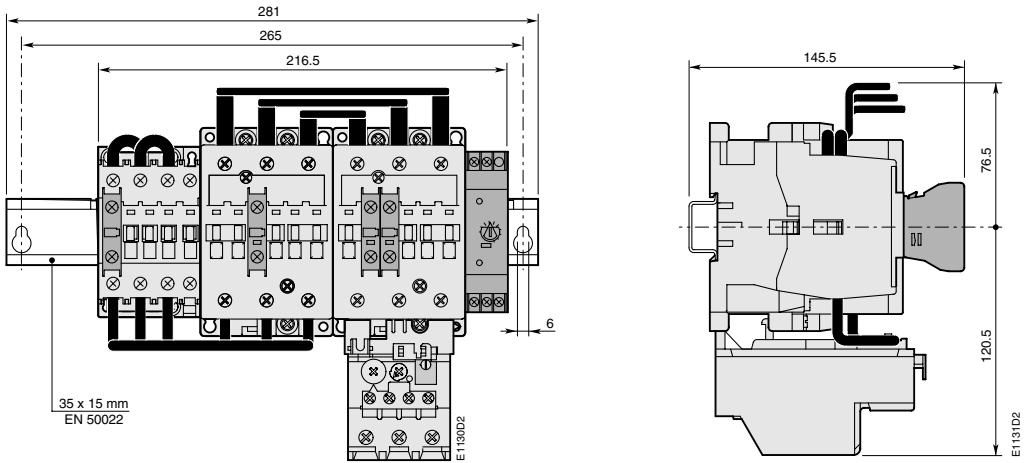

**YKA 50-30 + TA 75 DU, YKA 63-30 + TA 75 DU**

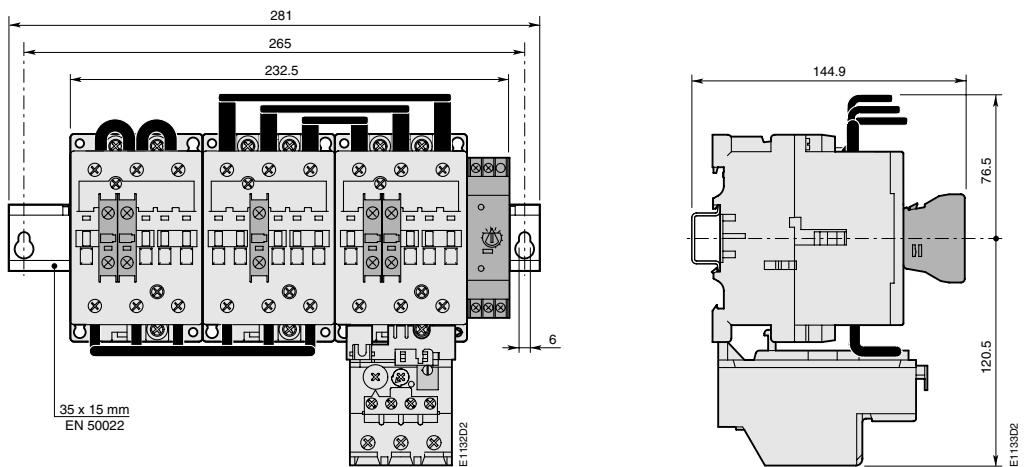

**YKA 75-30 + TA 75 DU**

Detailed dimension drawings available in DXF and PDF formats.

# VOA..-30M Reversing Contactors VOA..-40Z Changeover Contactors

## Dimensions (in mm)

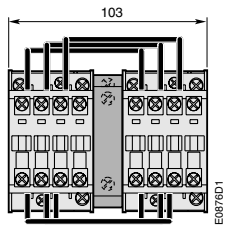

VOA 9-30M ... VOA 16-30M

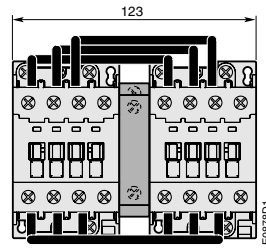
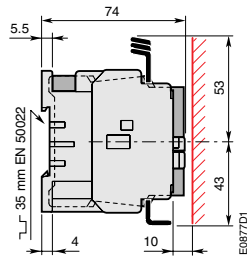

VOA 26-30M

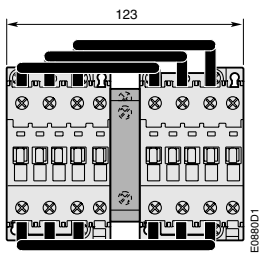
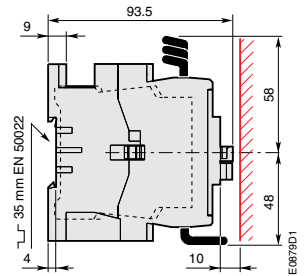

VOA 30-30M, VOA 40-30M

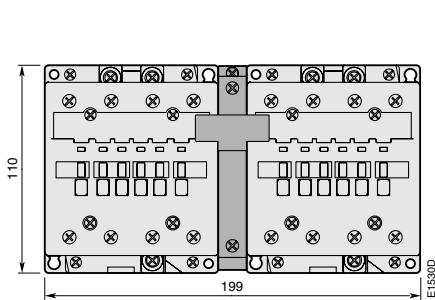
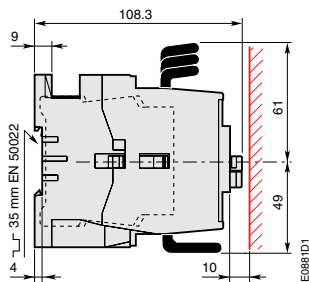

VOA 45-40Z ... VOA 75-40Z

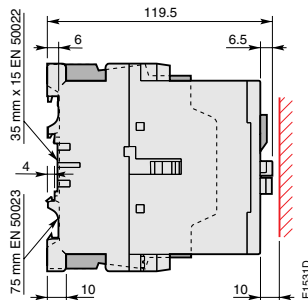



# Mini Contactors

## Dimensions (in mm)

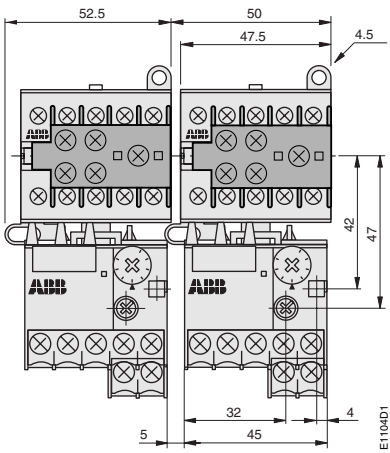

**B 6, B 7 + CAF 6 + T 7 DU**

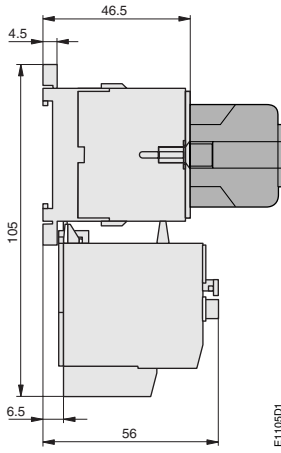

E1105D1

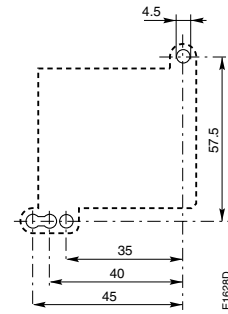

E1628D

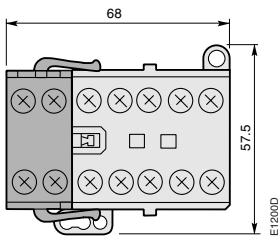

E1200D

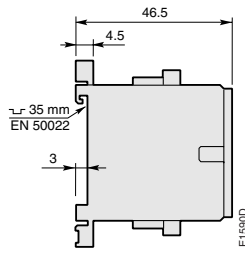

E1590D

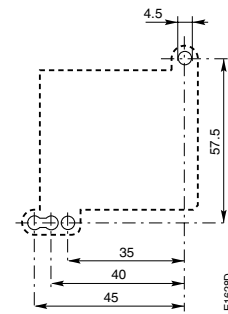

E1628D

**B 6, B 7, K 6 + CA 6**

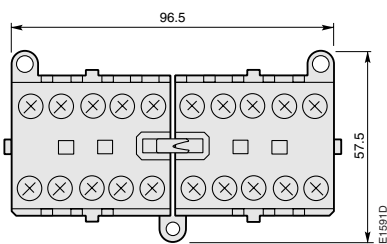

E1691D

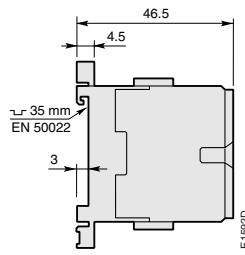

E1692D

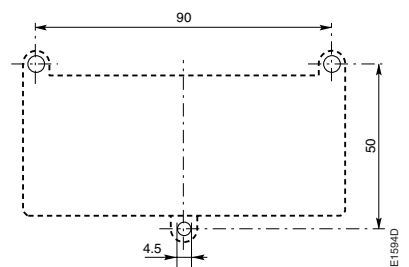

E1694D

**VB 6, VB 7**

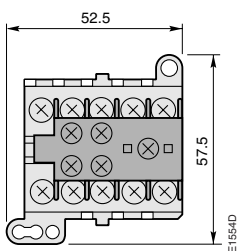

E1654D

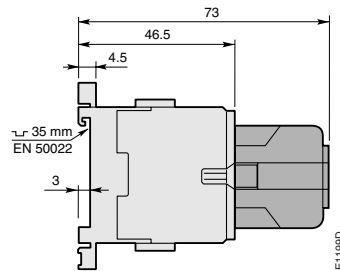

E1199D

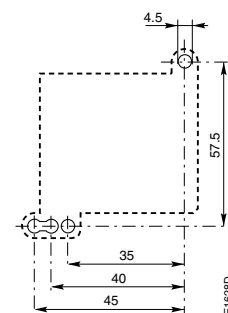

E1628D

**B 6, B 7, K 6 + CAF 6..**

Detailed dimension drawings available in DXF and PDF formats.

# D.O.L. Starters in Enclosure

## Wiring diagrams

D.A 9 ... D.A 16 starters in enclosure, factory assembled or kit form version

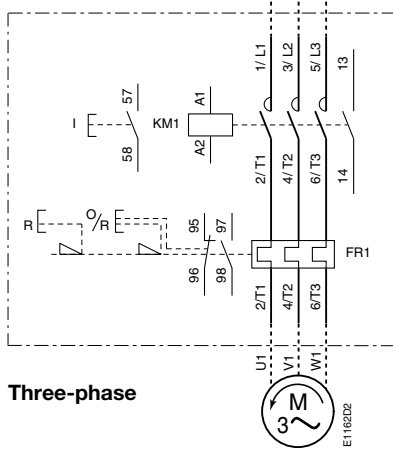

Three-phase

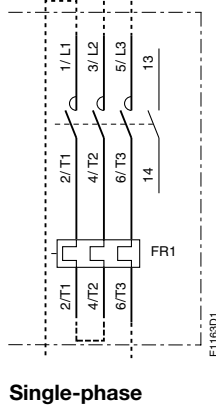

Single-phase

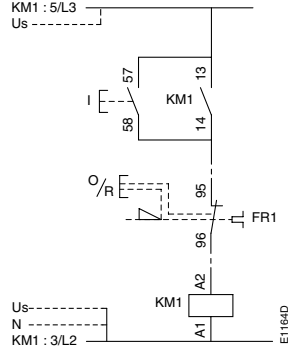

Local control

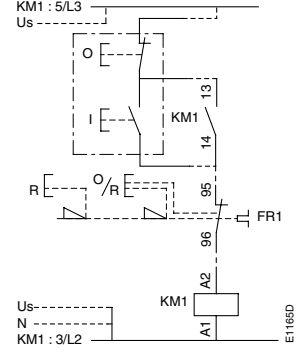

Remote control

# Star-Delta Starters

## Wiring diagrams

YKA...-30 star-delta starters, factory assembled or kit form version

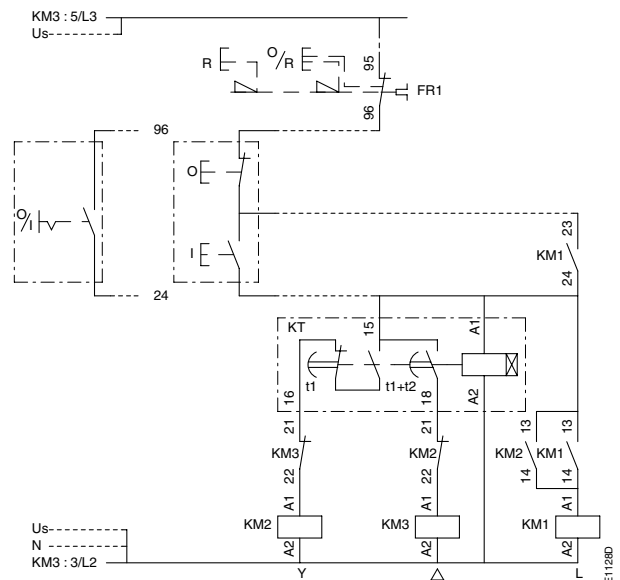
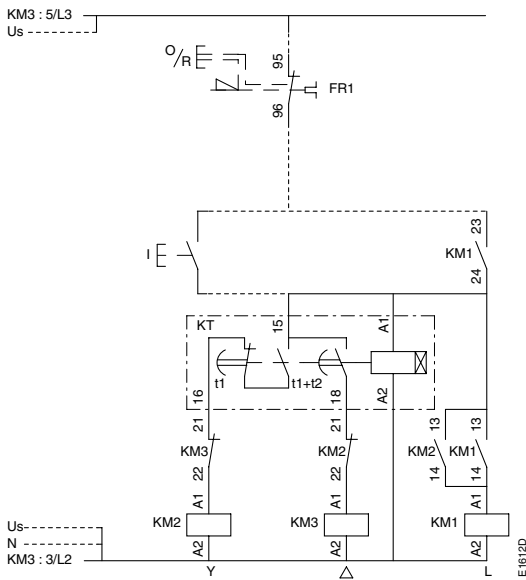
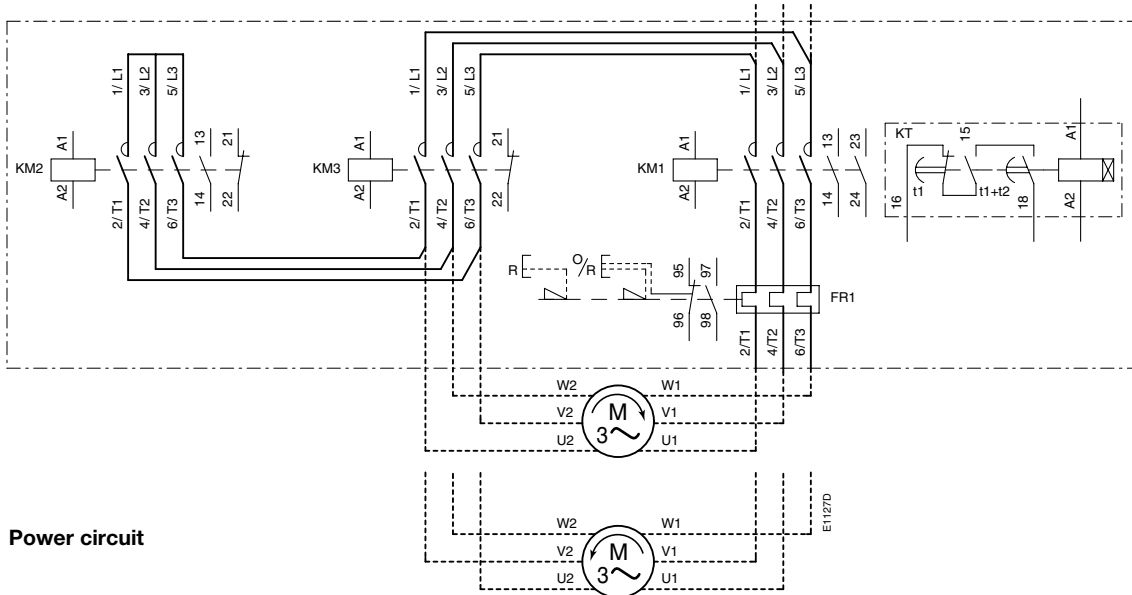

Wiring diagrams available in DXF and PDF formats.

# Reversing Contactors

## Wiring diagrams

### VOA 9-30M ... VOA 40-30M reversing contactors, factory-assembled version

with VM 5-1 mechanical interlocking, electrical interlocking by built-in auxiliary contacts.

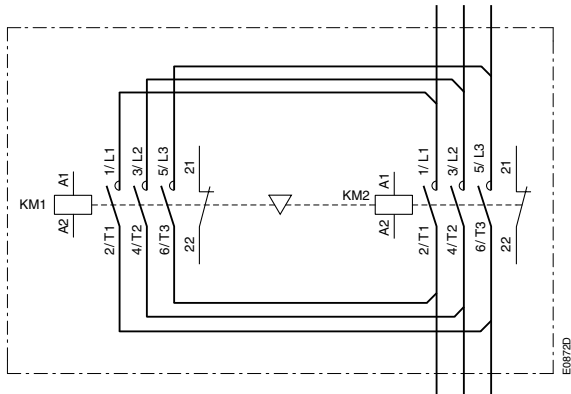

Power circuit

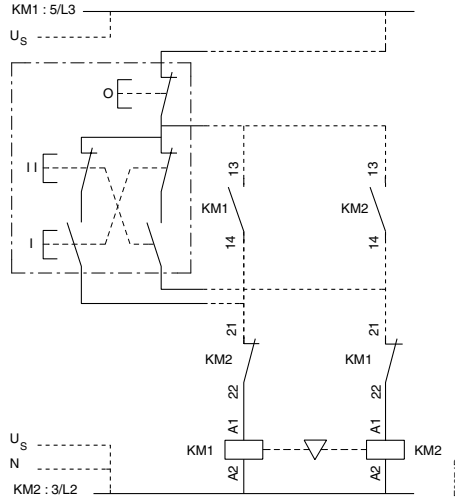

Remote control

For the hold-in contacts (13-14) of the KM1 and KM2 contactors, supply separately 2 x CA 5-10 type N.O. auxiliary contacts (see page 27).

### VOA 9-30M ... VOA 40-30M reversing contactors, kit form version

with VE 5-1 mechanical and electrical interlocking.

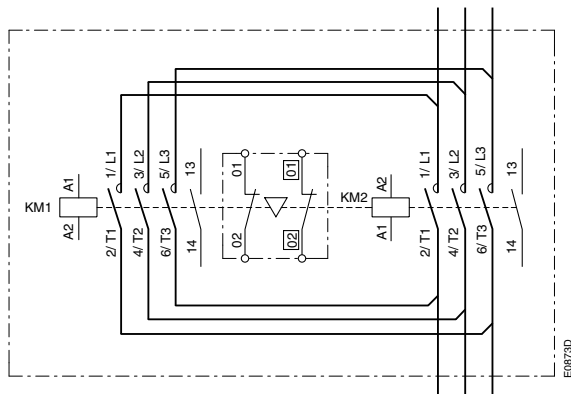

Power circuit

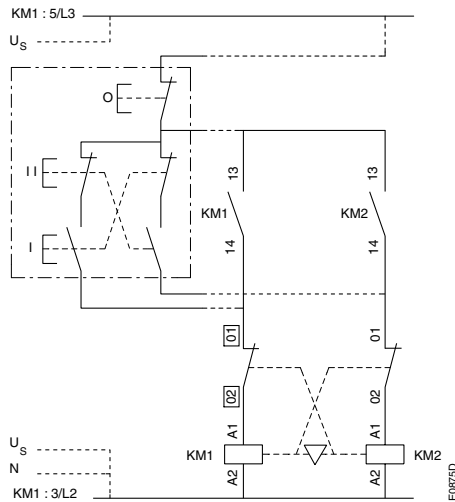

Remote control

N.O. auxiliary contacts (13-14) built into the KM1 and KM2 contactors, are available for the hold-in function of the KM1 and KM2 contactors.

# Reversing Contactors Changeover Contactors

## Wiring diagrams

**Reversing contactors in kit form version built with:**

- 2 x A 95-30-00 or A 110-30-00 contactors,
- VE 5-2 mechanical and electrical interlocking.

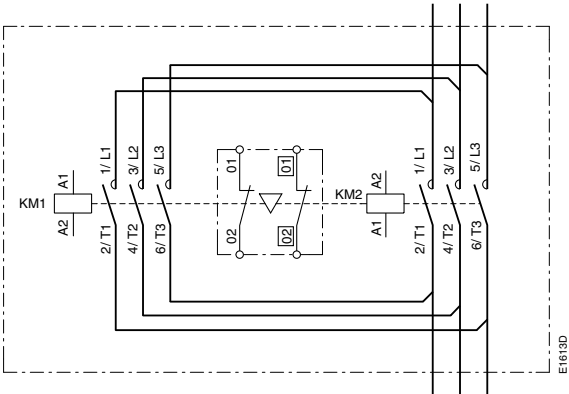

**Power circuit**

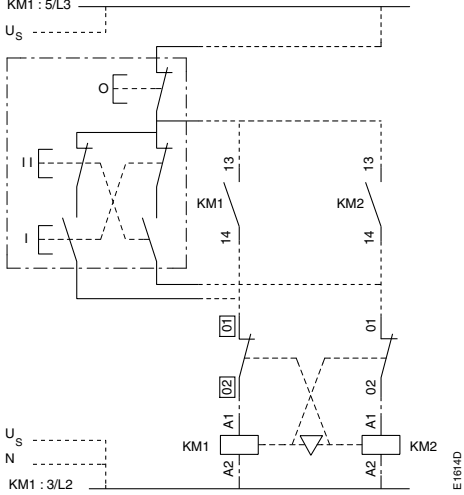

For the hold-in contacts (13-14) of the KM1 and KM2 contactors, supply separately 2 x CA 5-10 type N.O. auxiliary contacts (see page 27).

**Remote control**

**VOA 45-40Z ... VOA 75-40Z changeover contactors, factory-assembled or kit form version with VE 5-1 mechanical and electrical interlocking.**

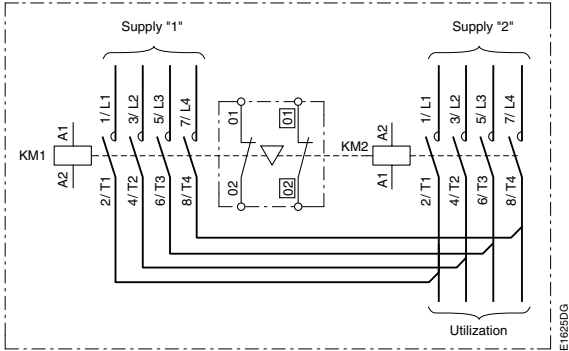

**Power circuit**

Wiring diagrams available in DXF and PDF formats.

**ABB Control**

10, rue Ampère Z.I. - B.P. 114  
F-69685 Chassieu cedex / France  
Telephone: +33 (0) 4 7222 1722  
Telefax: +33 (0) 4 7222 1935  
<http://www.abb.com/lowvoltage>

**ABB Control AB**

S-721 61 Västerås / Sweden  
Telephone: +46 (0) 21 32 07 00  
Telefax: +46 (0) 21 12 60 01  
<http://www.abb.com/lowvoltage>

As part of its on-going product improvement, ABB reserves the right to modify the characteristics or the products described in this document. The information given is not-contractual. For further details please contact the ABB company marketing these products in your country.

**ABB STOTZ-KONTAKT GmbH**

P.O. Box 101680  
D-69006 Heidelberg / Germany  
Telephone: +49 (0) 6221 701-00  
Telefax: +49 (0) 6221 701-1115  
<http://www.abb.com/lowvoltage>